

**CURVES**  
G10091E

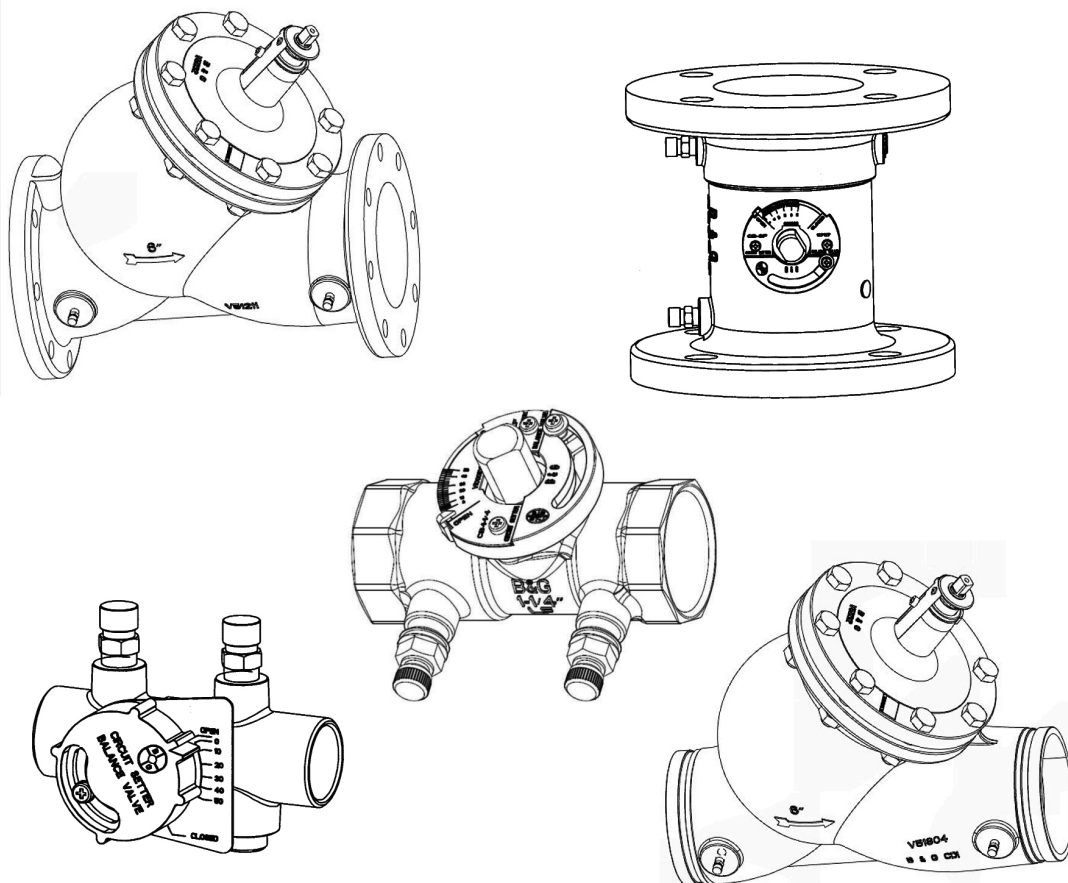

# Circuit Setter® Plus

Calibrated Balance Valve

Performance Curves

Sizes 1/2" Through 12"

NPT, Sweat, Flanged and Grooved Connections



**Bell & Gossett**

a xylem brand

# Circuit Setter Plus Calibrated Balance Valve Performance Characteristics

## Table of Contents

Model.....	Page
RF - 1/2 .....	3
RF - 3/4 .....	4
CB - 1/2 .....	5
CB - 1/2S .....	6
CB - 3/4 .....	7
CB - 3/4S .....	8
CB - 1 and 1S .....	9
CB - 1-1/4 and 1-1/4S .....	10
CB - 1-1/2 and 1-1/2S .....	11
CB - 2 and 2S .....	12
CB - 2-1/2 and 2-1/2F .....	13
CB - 3 and 3F .....	14
CB - 4 .....	15
CB - 4F and 4G .....	16
CB - 5F and 5G .....	17
CB - 6F and 6G .....	18
CB - 8F and 8G .....	19
CB - 10F and 10G .....	20
CB - 12F and 12G .....	21

# Circuit Setter Plus Calibrated Balance Valve Performance Characteristics

Part No. 117410 and 117410LF

Model No. RF-1/2 and RF-1/2LF

**FOR SYSTEM BALANCING  
AND SYSTEM PRESSURE DROP**

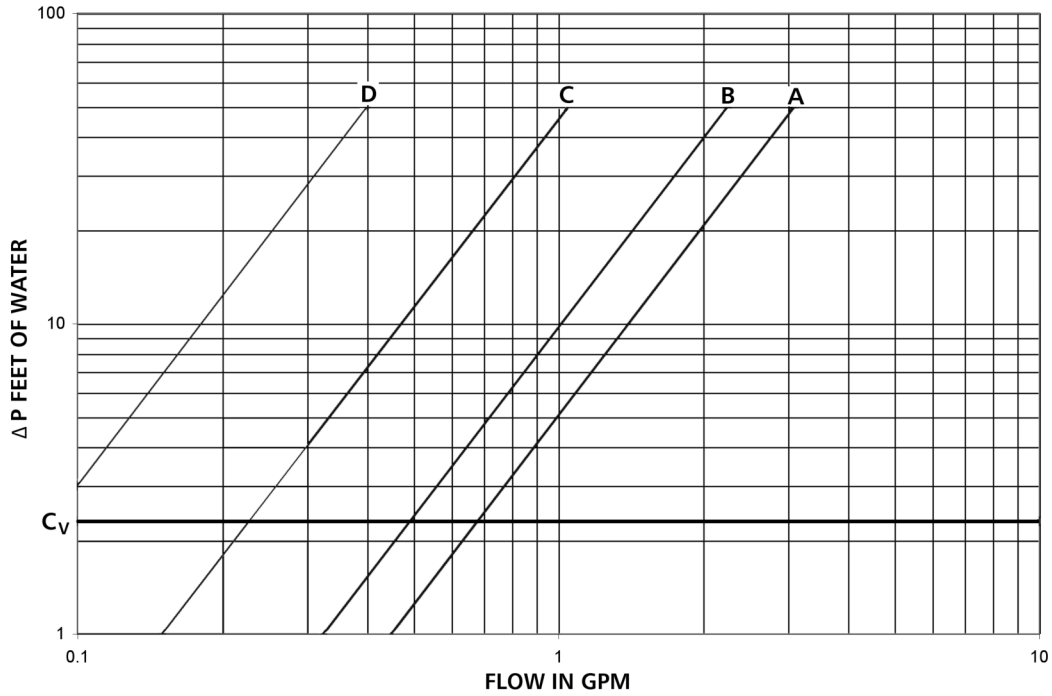

**FOR SYSTEM BALANCING  
AND SYSTEM PRESSURE DROP**

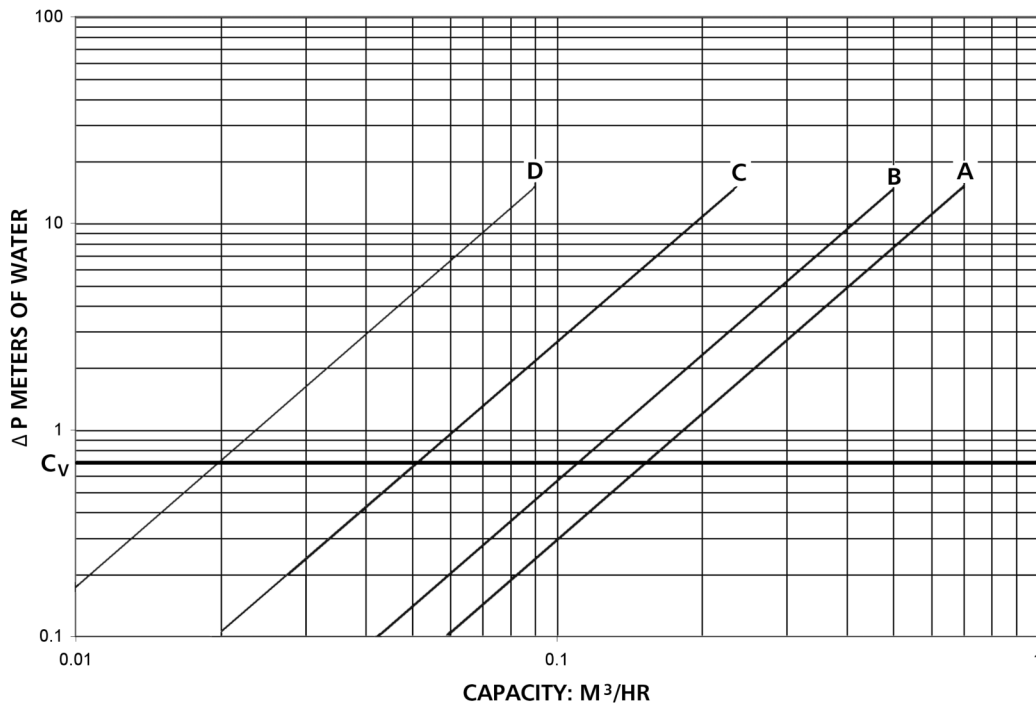

# Circuit Setter Plus Calibrated Balance Valve Performance Characteristics

Part No. 117411 and 117411LF

Model No. RF-3/4 and RF-3/4LF

**FOR SYSTEM BALANCING  
AND SYSTEM PRESSURE DROP**

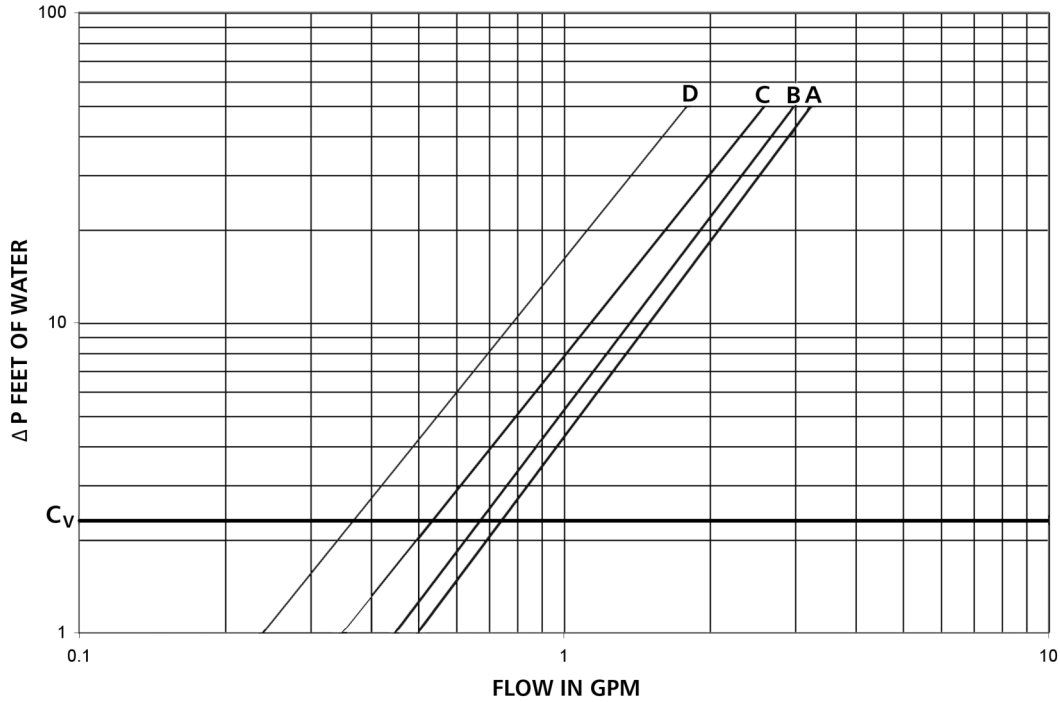

**FOR SYSTEM BALANCING  
AND SYSTEM PRESSURE DROP**

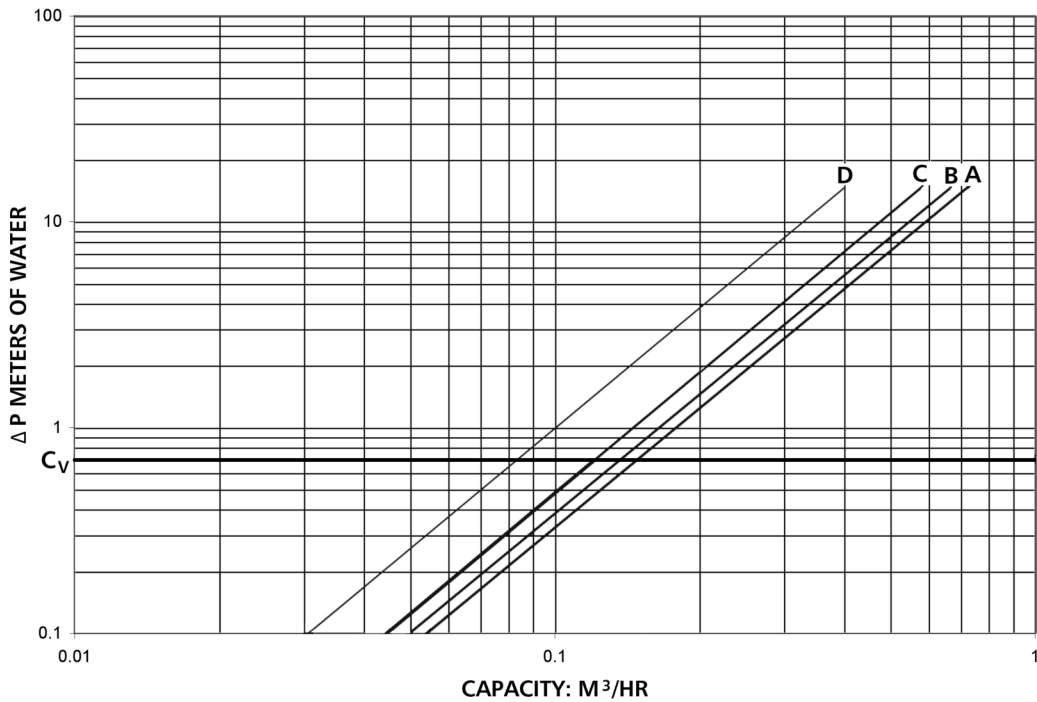

# Circuit Setter Plus Calibrated Balance Valve Performance Characteristics

Part No. 117414 and 117414LF

Model No. CB-1/2 and CB-1/2LF

**FOR SYSTEM BALANCING  
AND SYSTEM PRESSURE DROP**

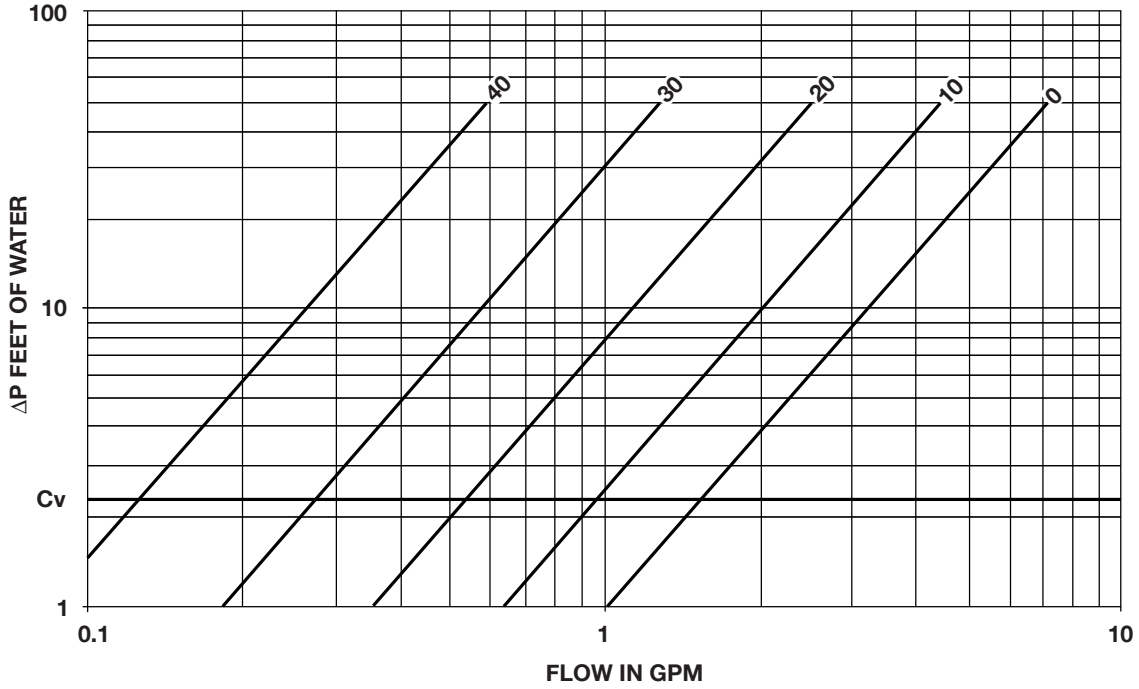

**FOR SYSTEM BALANCING  
AND SYSTEM PRESSURE DROP**

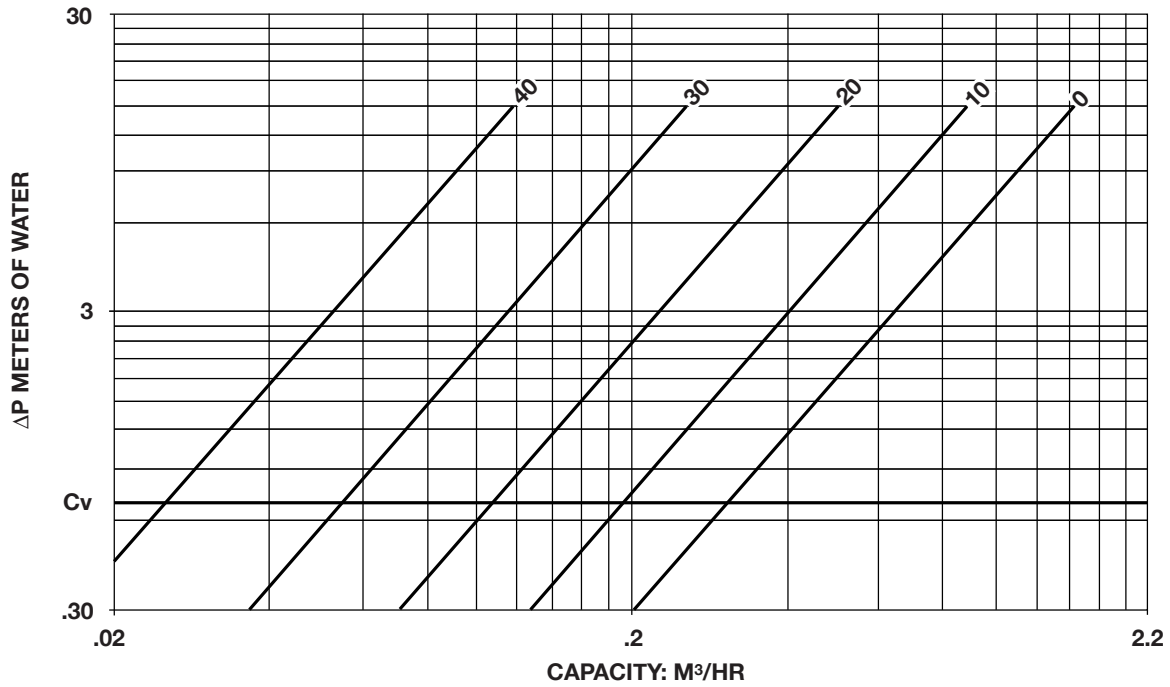

# Circuit Setter Plus Calibrated Balance Valve Performance Characteristics

Part No. 117412 and 117412LF

Model No. CB-1/2S and CB-1/2SLF

**FOR SYSTEM BALANCING  
AND SYSTEM PRESSURE DROP**

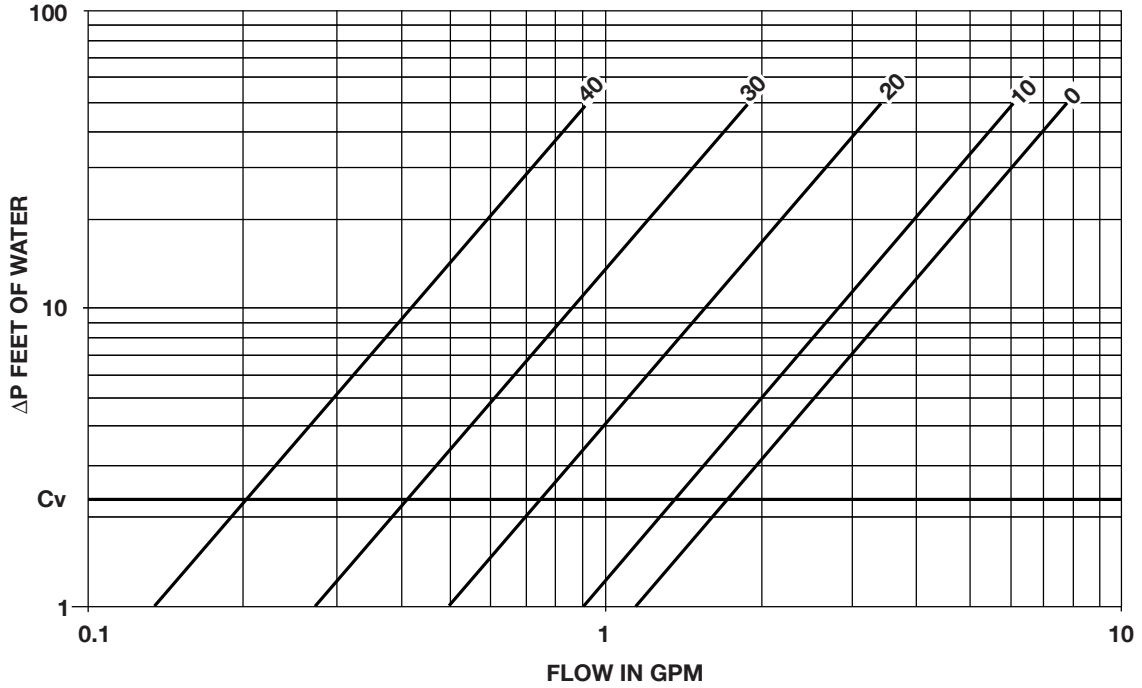

**FOR SYSTEM BALANCING  
AND SYSTEM PRESSURE DROP**

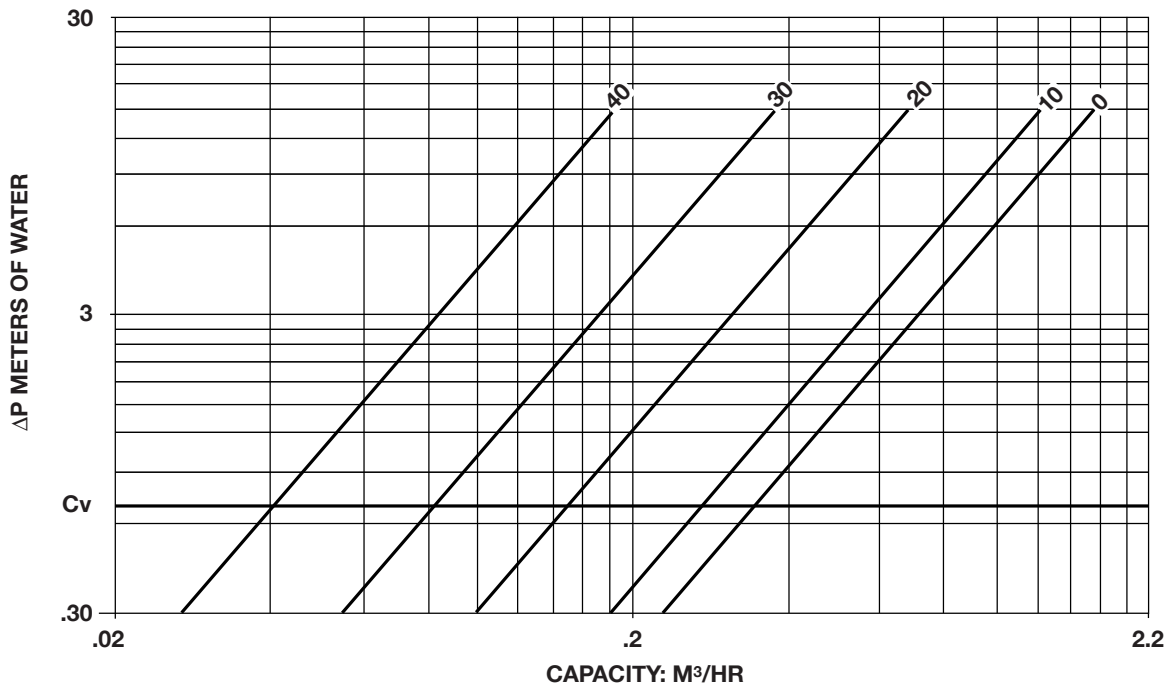

# Circuit Setter Plus Calibrated Balance Valve Performance Characteristics

Part No. 117415 and 117415LF

Model No. CB-3/4 and CB-3/4LF

**FOR SYSTEM BALANCING  
AND SYSTEM PRESSURE DROP**

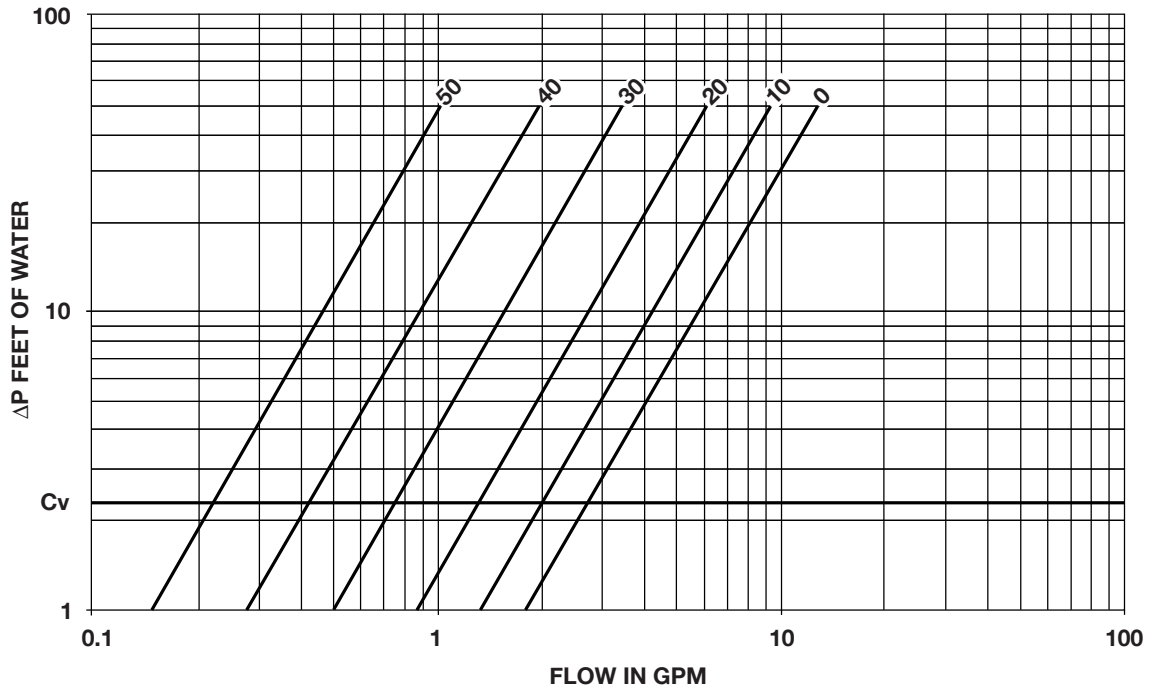

**FOR SYSTEM BALANCING  
AND SYSTEM PRESSURE DROP**

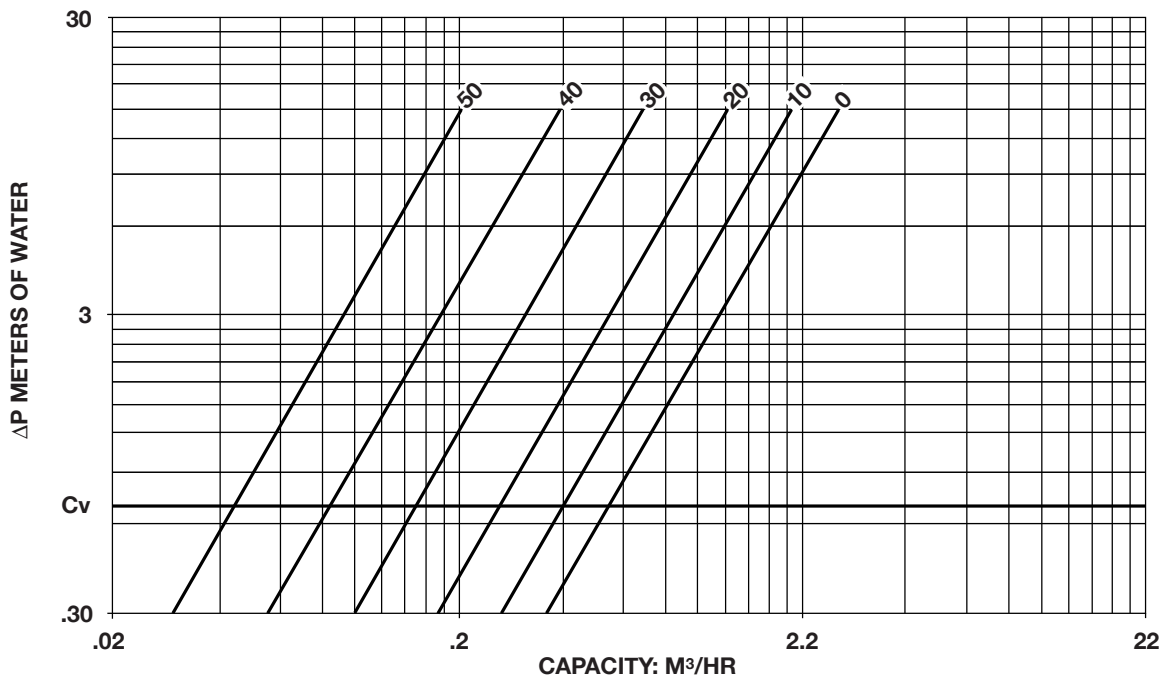

# Circuit Setter Plus Calibrated Balance Valve Performance Characteristics

Part No. 117413 and 117413LF

Model No. CB-3/4S and CB-3/4SLF

**FOR SYSTEM BALANCING  
AND SYSTEM PRESSURE DROP**

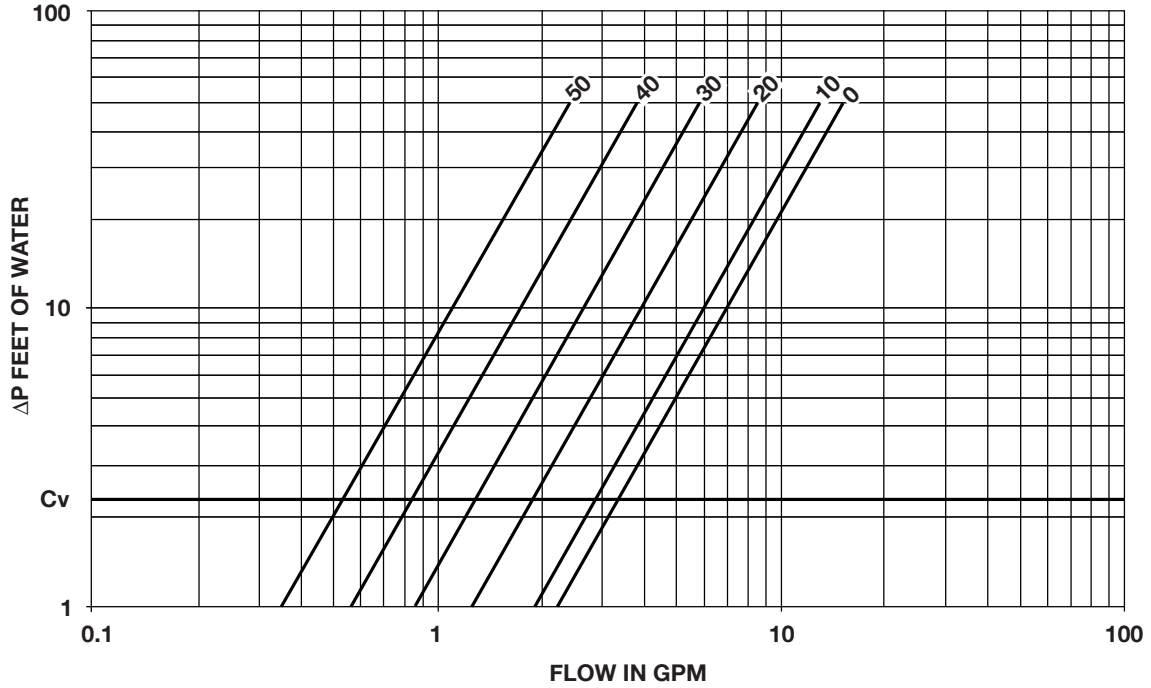

**FOR SYSTEM BALANCING  
AND SYSTEM PRESSURE DROP**

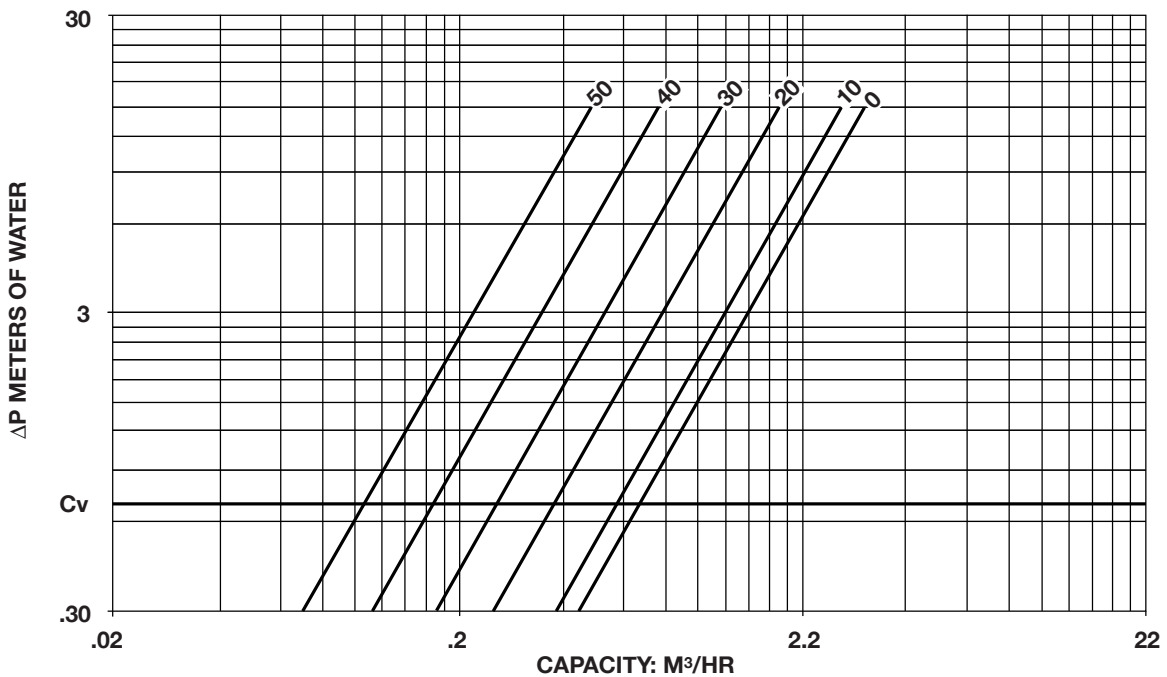



# Circuit Setter Plus Calibrated Balance Valve Performance Characteristics

Part No. 117416 and 117416LF  
Part No. 117401 and 117401LF

Model No. CB-1 and CB-1LF  
Model No. CB-1S and CB-1SLF

**FOR SYSTEM BALANCING  
AND SYSTEM PRESSURE DROP**

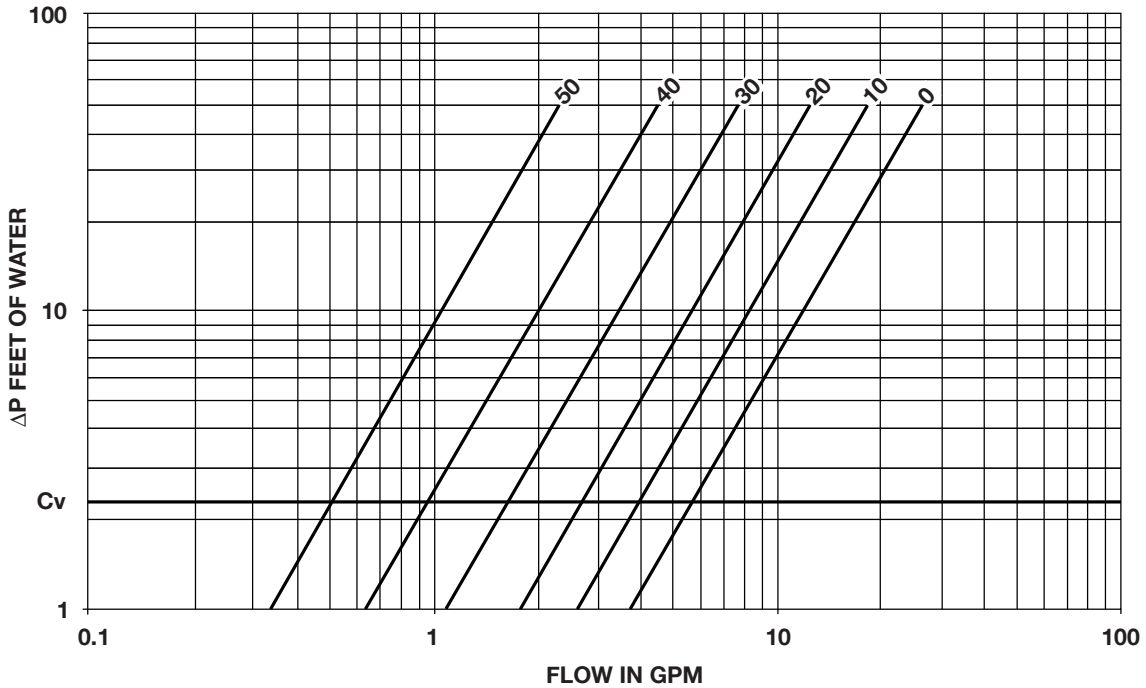

**FOR SYSTEM BALANCING  
AND SYSTEM PRESSURE DROP**

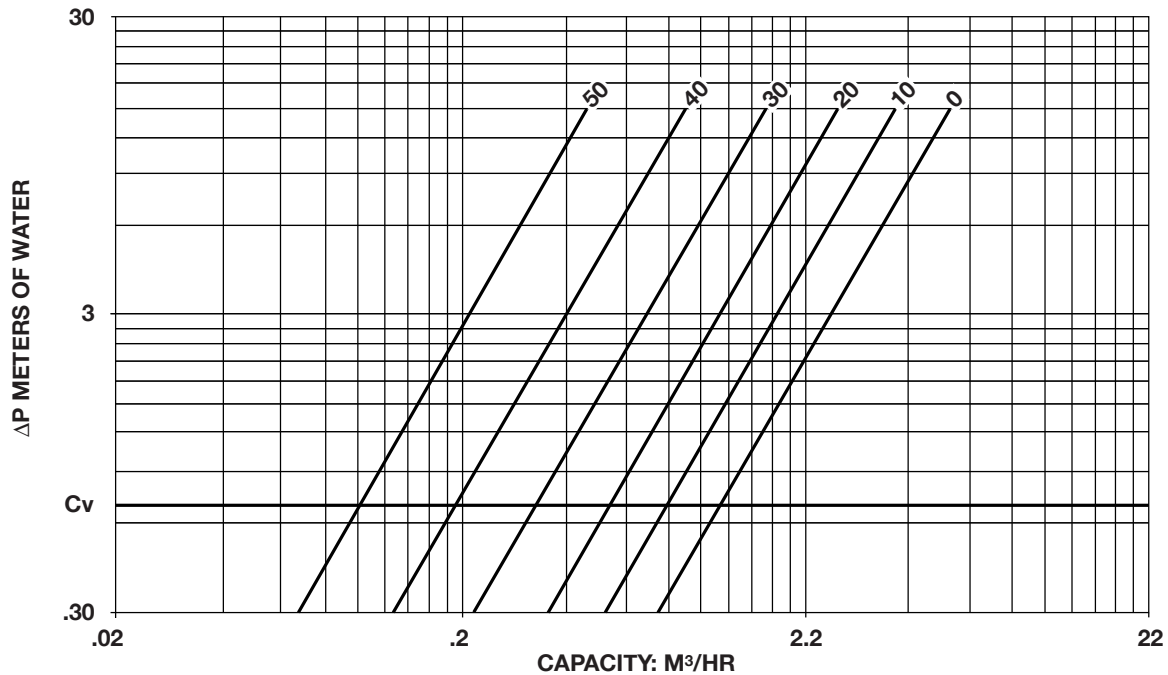

# Circuit Setter Plus Calibrated Balance Valve Performance Characteristics

Part No. 117103 and 117103LF  
Part No. 117402 and 117402LF

Model No. CB-1<sup>1</sup>/<sub>4</sub> and CB-1<sup>1</sup>/<sub>4</sub>LF  
Model No. CB-1<sup>1</sup>/<sub>4</sub>S and CB-1<sup>1</sup>/<sub>4</sub>SLF

**FOR SYSTEM BALANCING  
AND SYSTEM PRESSURE DROP**

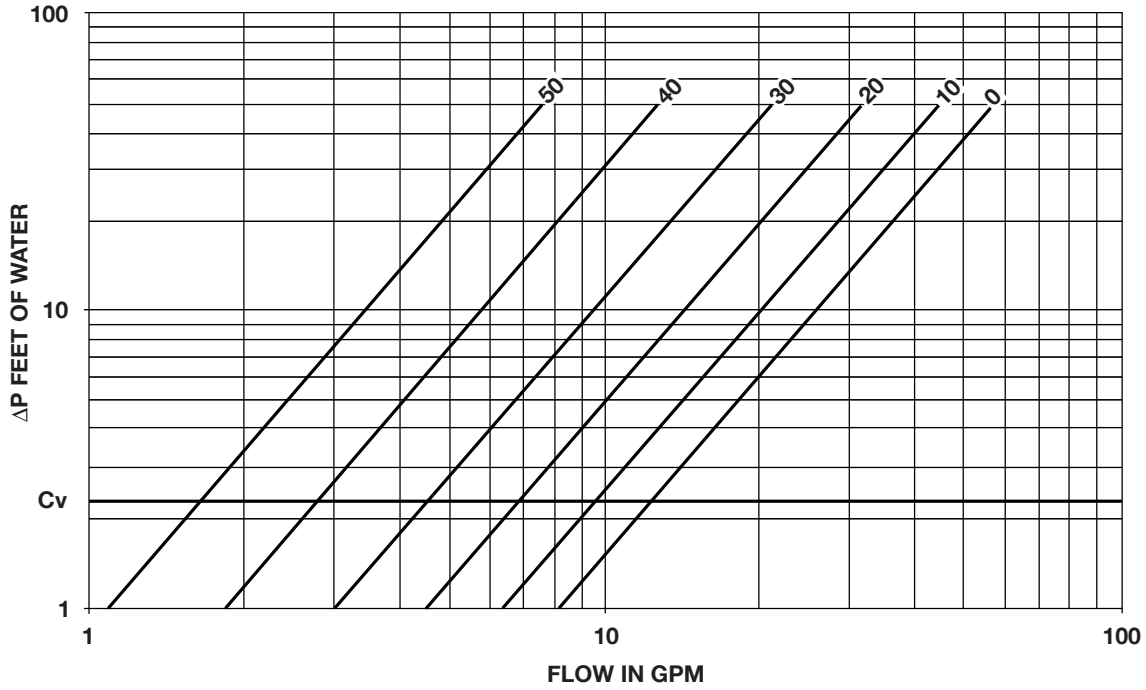

**FOR SYSTEM BALANCING  
AND SYSTEM PRESSURE DROP**

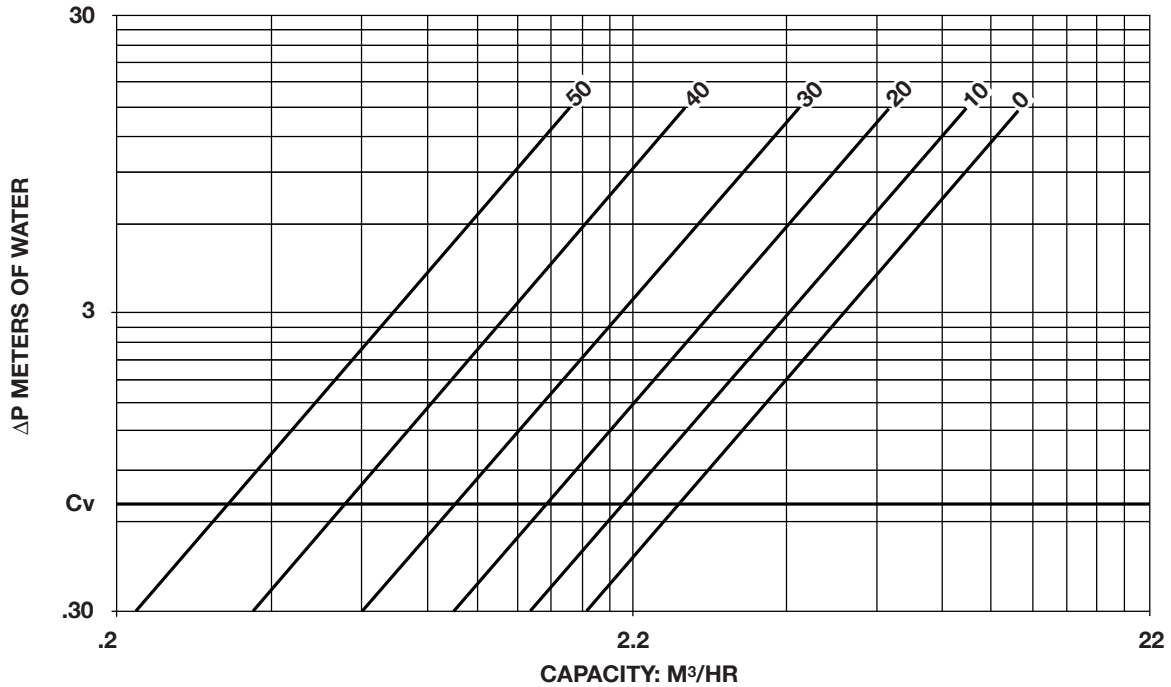

# Circuit Setter Plus Calibrated Balance Valve Performance Characteristics

Part No. 117104 and 117104LF  
Part No. 117403 and 117403LF

Model No. CB-1<sup>1</sup>/<sub>2</sub> and CB-1<sup>1</sup>/<sub>2</sub>LF  
Model No. CB-1<sup>1</sup>/<sub>2</sub>S and CB-1<sup>1</sup>/<sub>2</sub>SLF

**FOR SYSTEM BALANCING  
AND SYSTEM PRESSURE DROP**

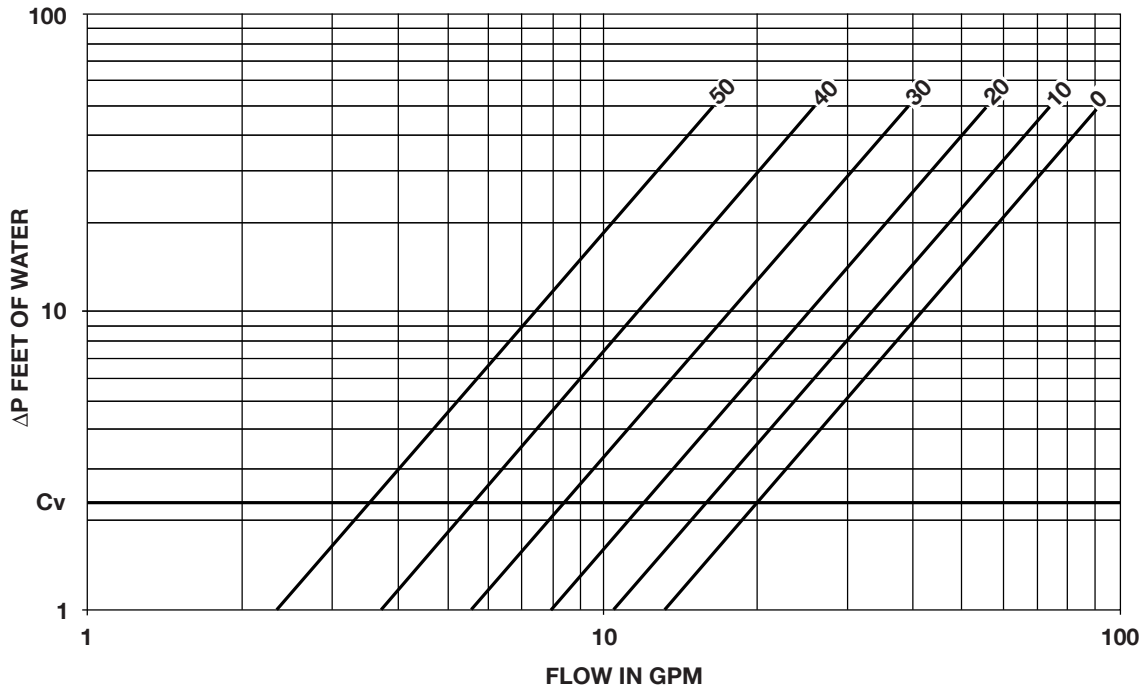

**FOR SYSTEM BALANCING  
AND SYSTEM PRESSURE DROP**

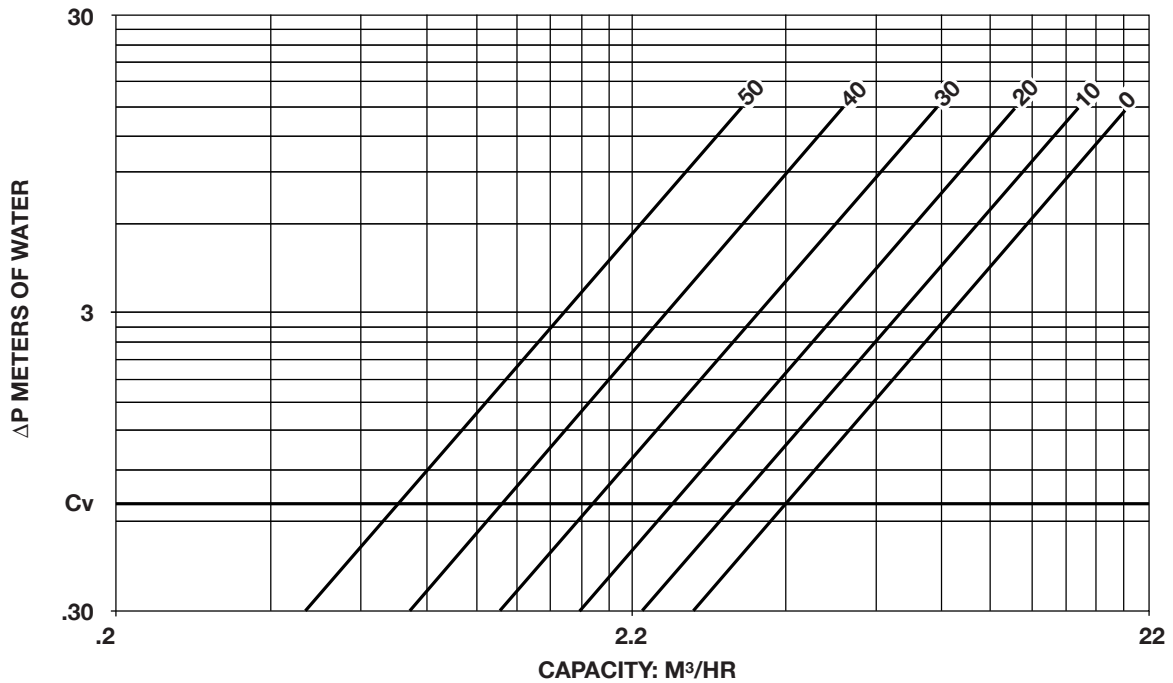

# Circuit Setter Plus Calibrated Balance Valve Performance Characteristics

Part No. 117105 and 117105LF  
Part No. 117404 and 117404LF

Model No. CB-2 and CB-2LF  
Model No. CB-2S and CB-2SLF

**FOR SYSTEM BALANCING  
AND SYSTEM PRESSURE DROP**

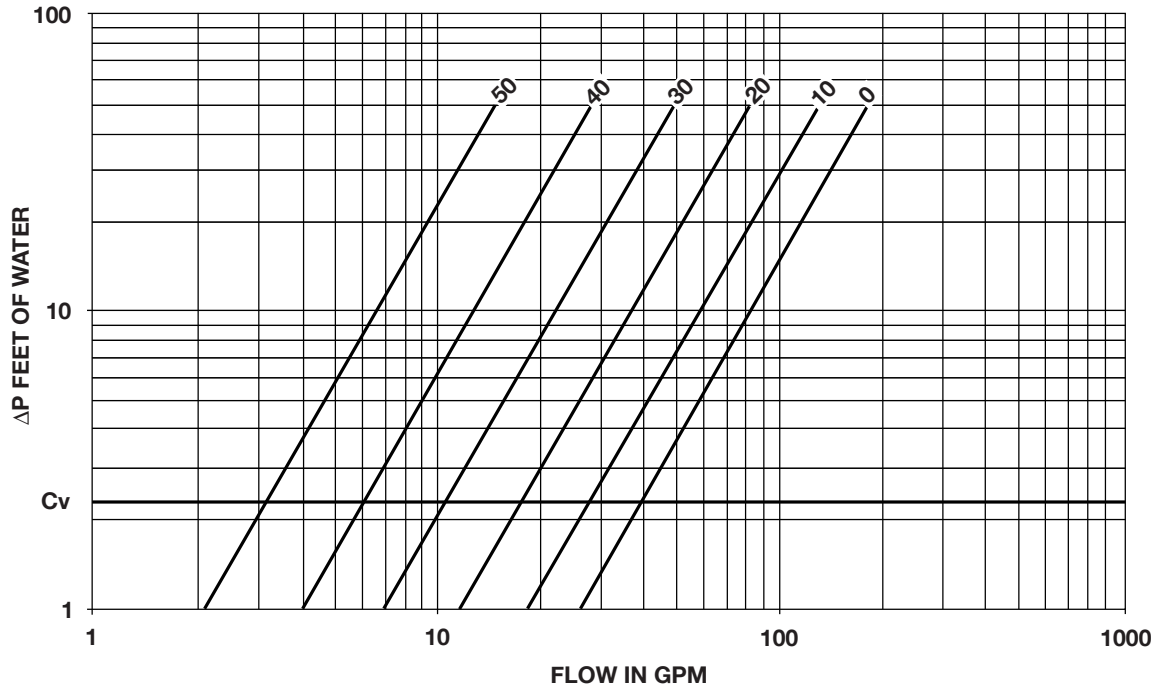

**FOR SYSTEM BALANCING  
AND SYSTEM PRESSURE DROP**

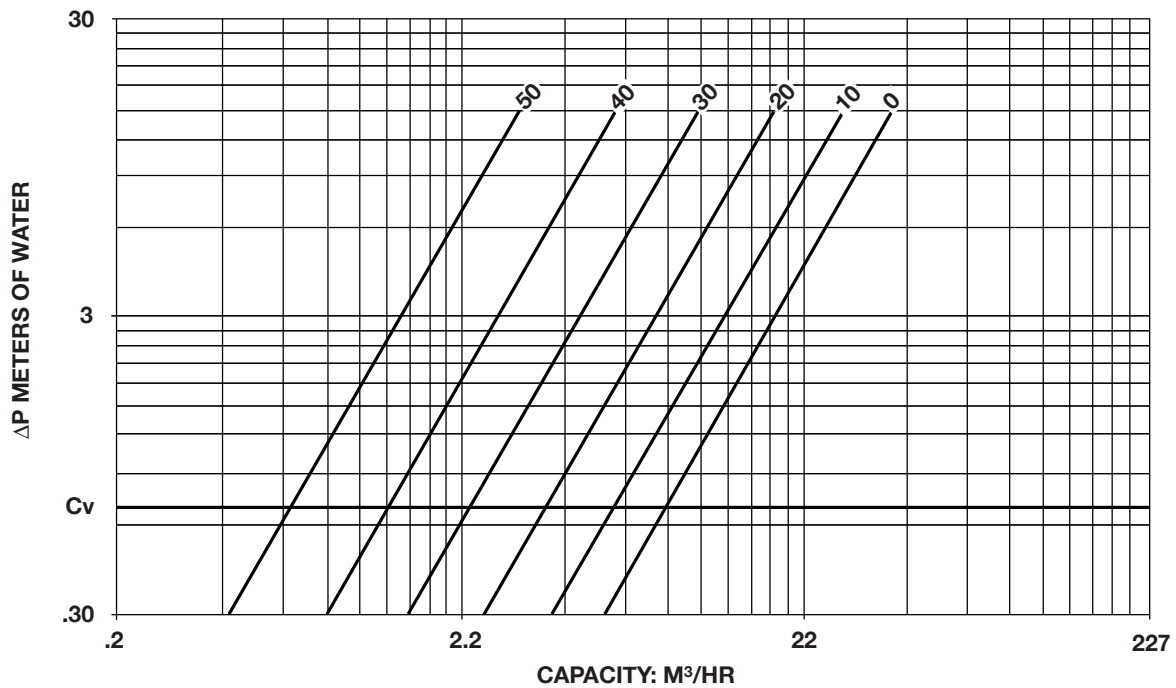

# Circuit Setter Plus Calibrated Balance Valve Performance Characteristics

Part No. 117106 and 117106LF  
Part No. 117116

Model No. CB-2<sup>1</sup>/<sub>2</sub> and CB-2<sup>1</sup>/<sub>2</sub>LF  
Model No. CB-2<sup>1</sup>/<sub>2</sub>F

**FOR SYSTEM BALANCING  
AND SYSTEM PRESSURE DROP**

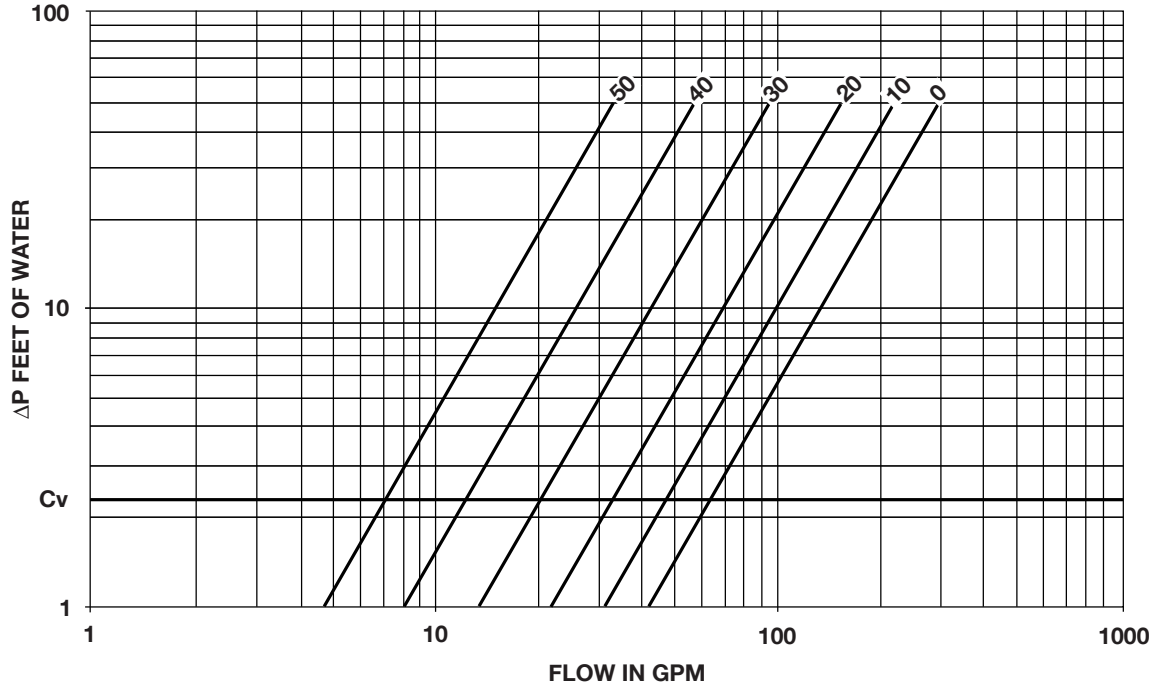

**FOR SYSTEM BALANCING  
AND SYSTEM PRESSURE DROP**

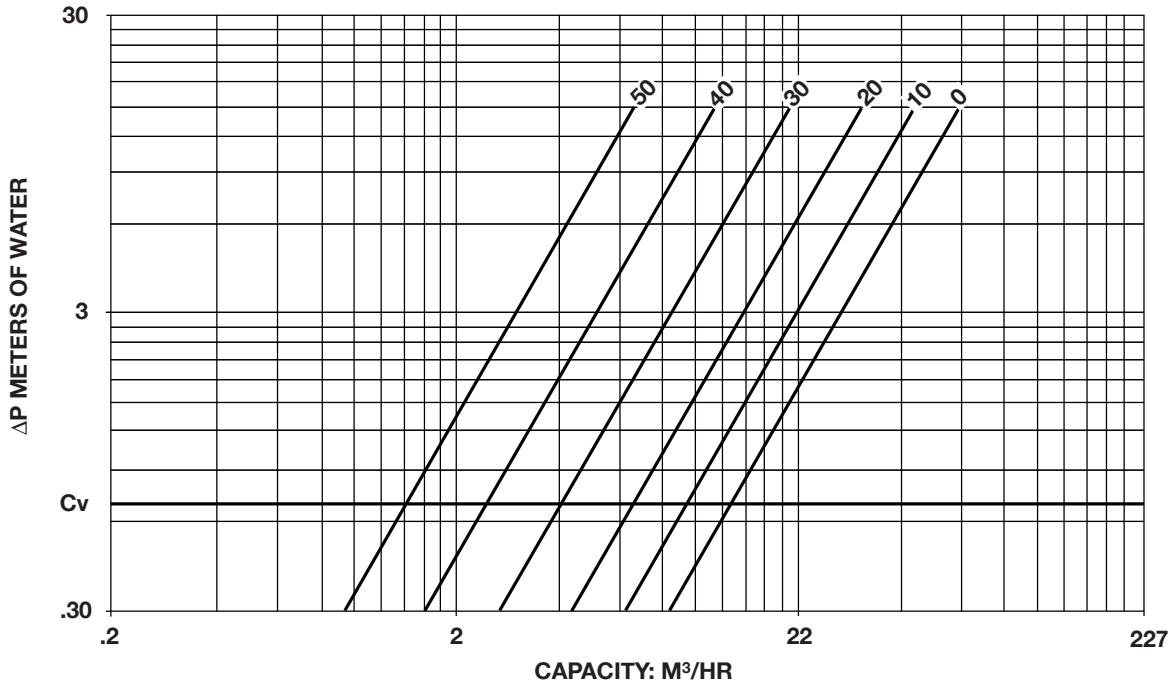

# Circuit Setter Plus Calibrated Balance Valve Performance Characteristics

Part No. 117107 and 117107LF  
Part No. 117117

Model No. CB-3 and CB-3LF  
Model No. CB-3F

**FOR SYSTEM BALANCING  
AND SYSTEM PRESSURE DROP**

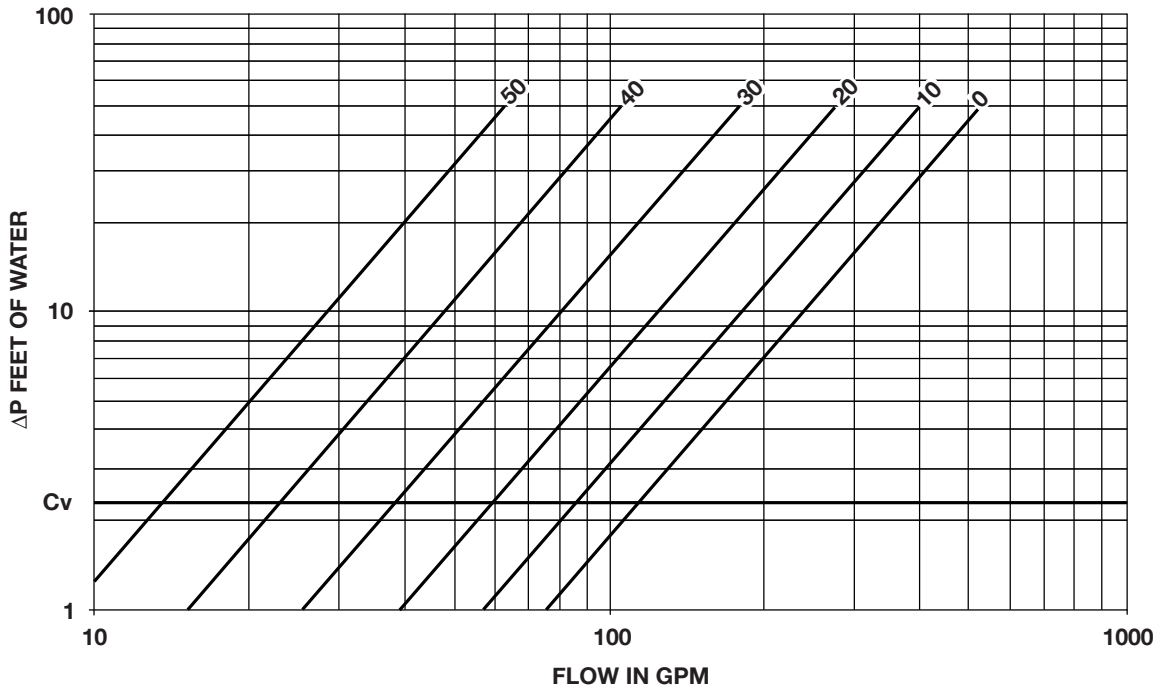

**FOR SYSTEM BALANCING  
AND SYSTEM PRESSURE DROP**

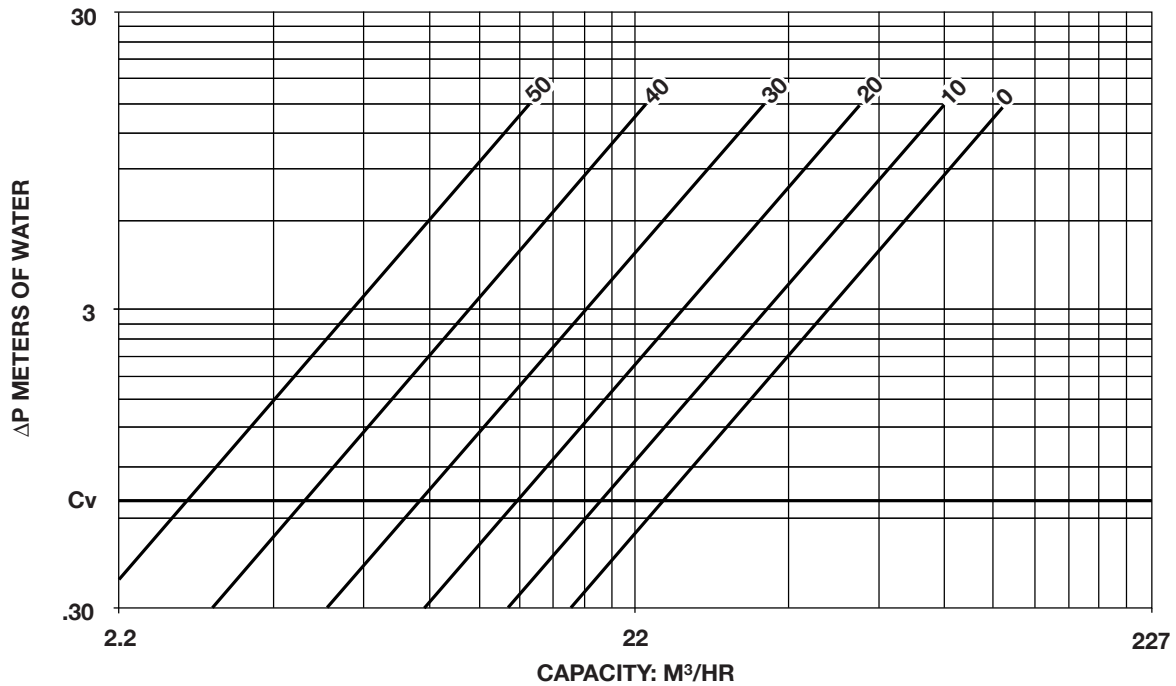

# Circuit Setter Plus Calibrated Balance Valve Performance Characteristics

Part No. 117035

Model No. CB-4

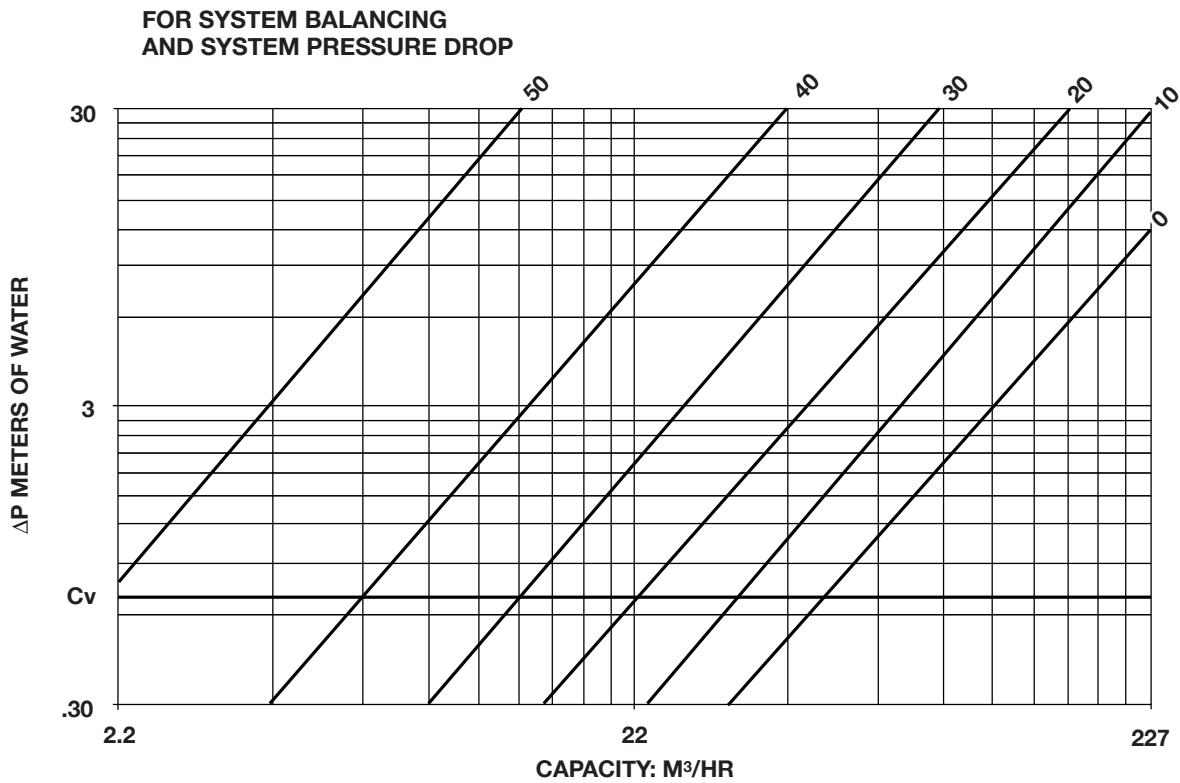
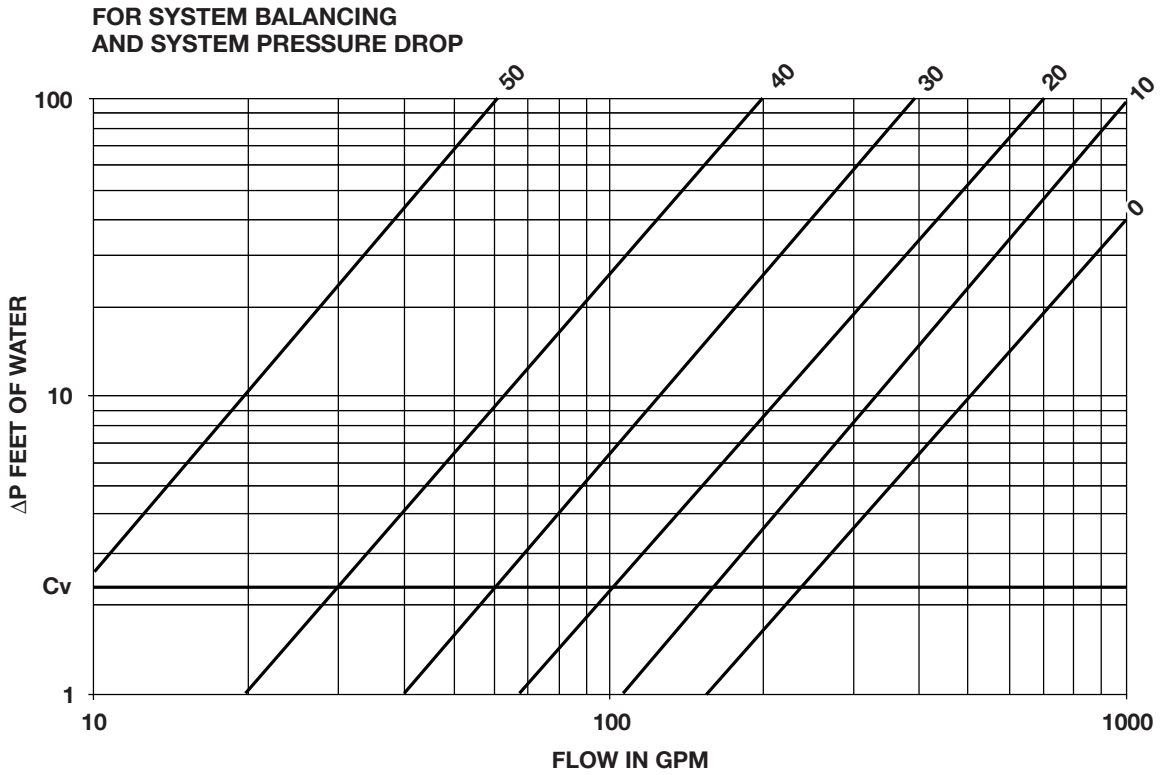

# Circuit Setter Plus Calibrated Balance Valve Performance Characteristics

Part No. 117112 (Old Design)	Model No. CB-4F
Part No. 117118 (Old Design)	Model No. CB-4G
Part No. 117470 (New Design)	Model No. CB-4F
Part No. 117476 (New Design)	Model No. CB-4G

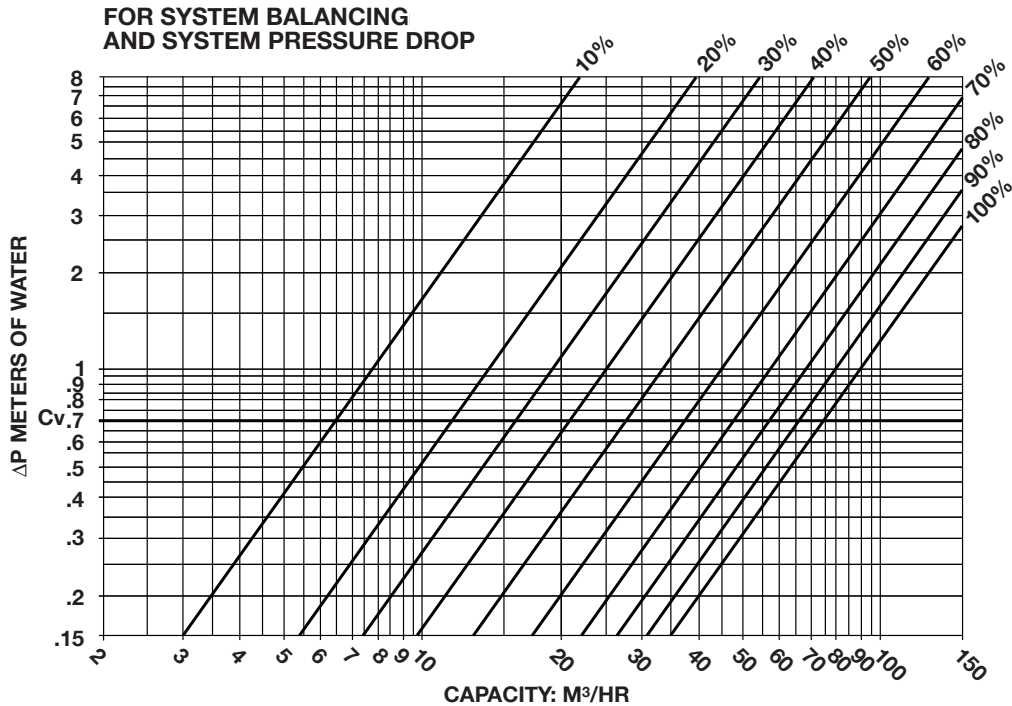
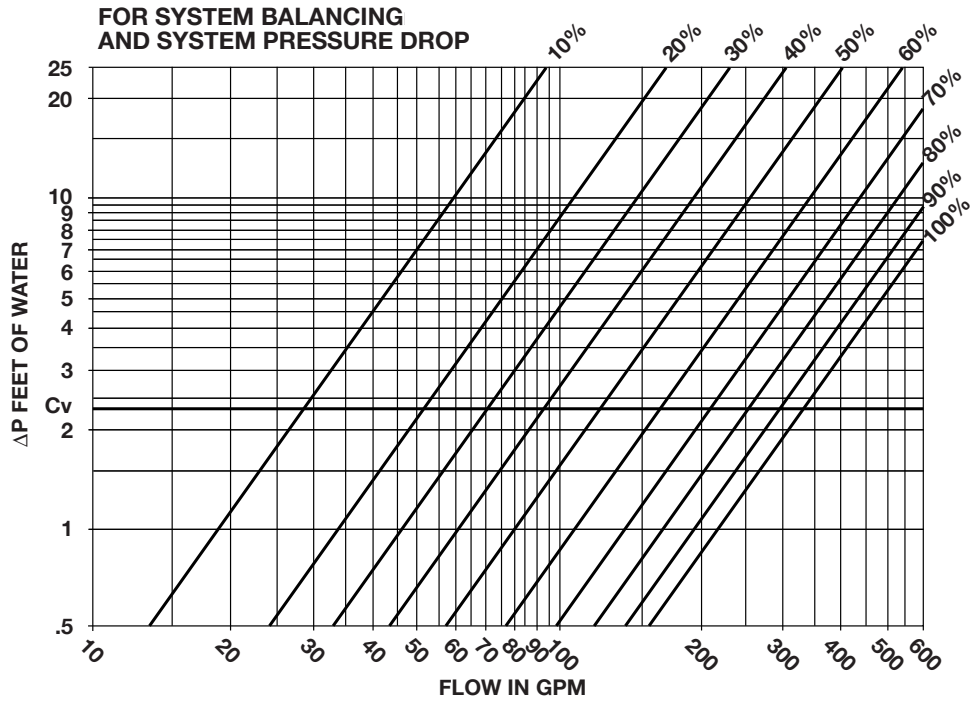



# Circuit Setter Plus Calibrated Balance Valve Performance Characteristics

Part No. 117113 (Old Design)	Model No. CB-5F
Part No. 117119 (Old Design)	Model No. CB-5G
Part No. 117471 (New Design)	Model No. CB-5F
Part No. 117477 (New Design)	Model No. CB-5G

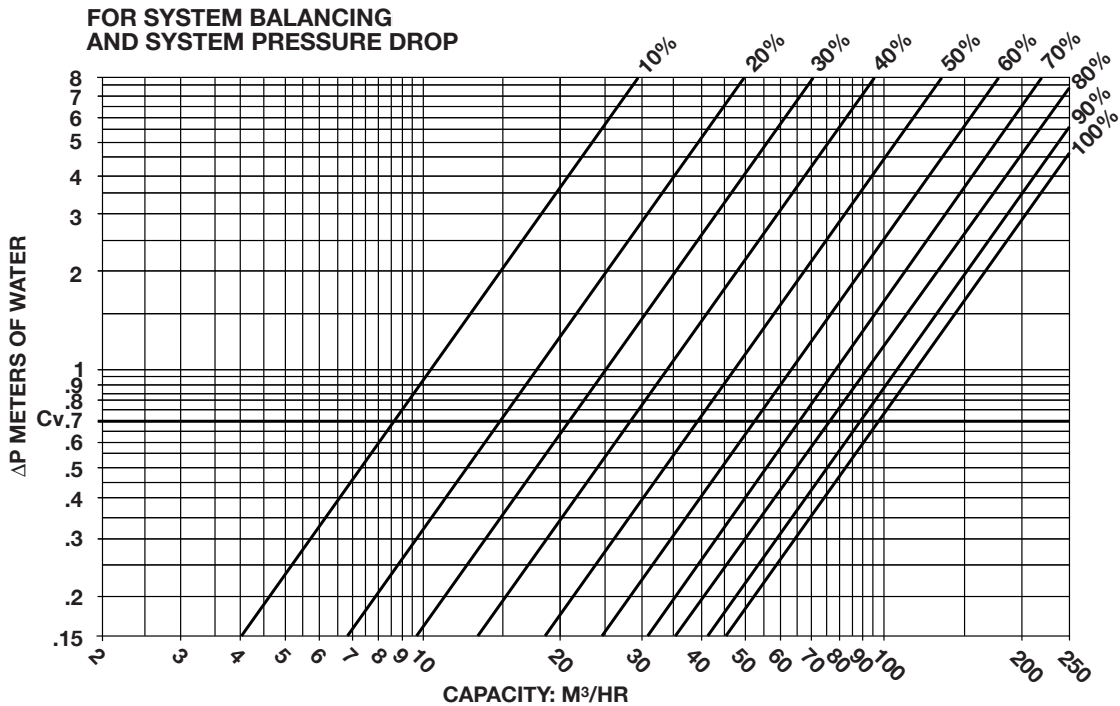
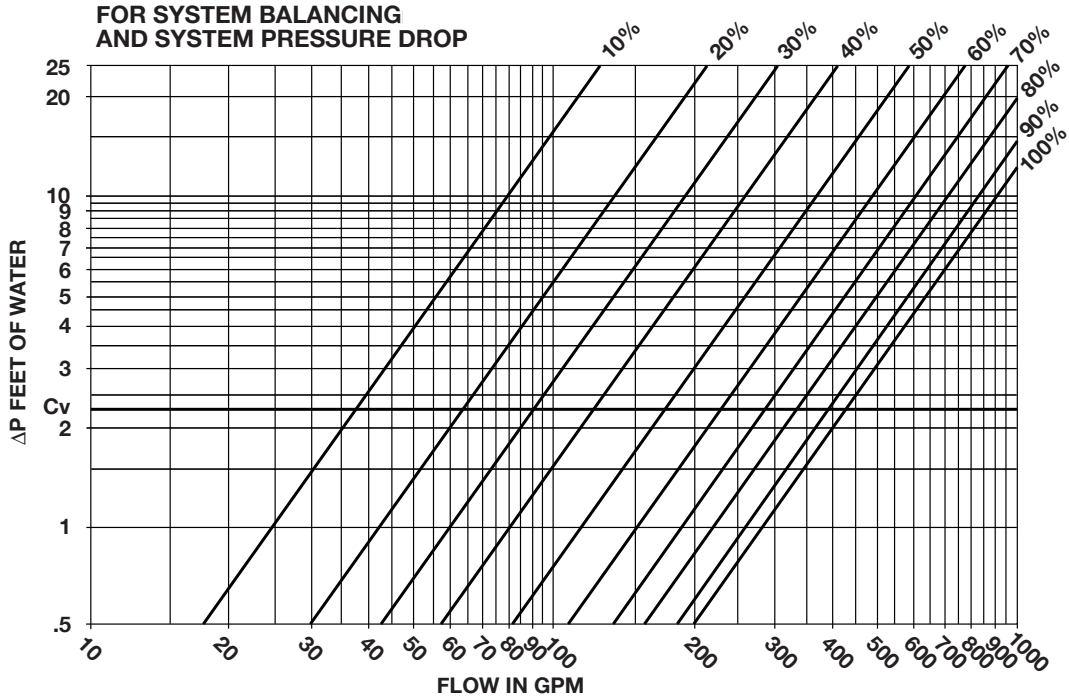

# Circuit Setter Plus Calibrated Balance Valve Performance Characteristics

Part No. 117114 (Old Design)	Model No. CB-6F
Part No. 117120 (Old Design)	Model No. CB-6G
Part No. 117472 (New Design)	Model No. CB-6F
Part No. 117478 (New Design)	Model No. CB-6G

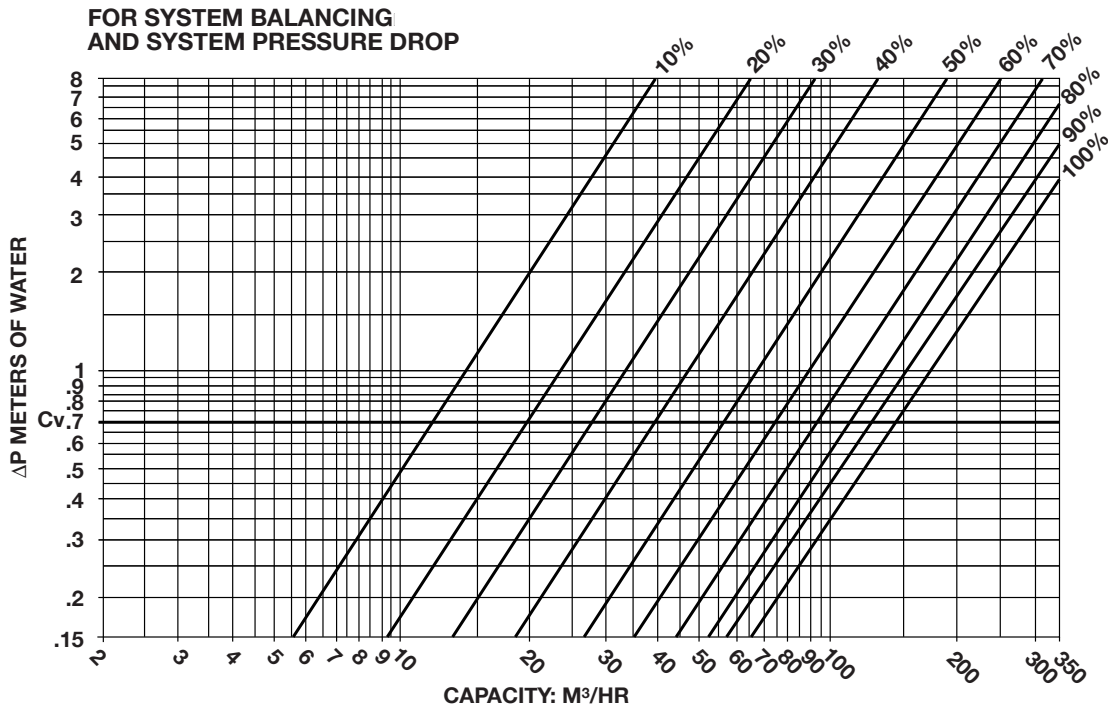
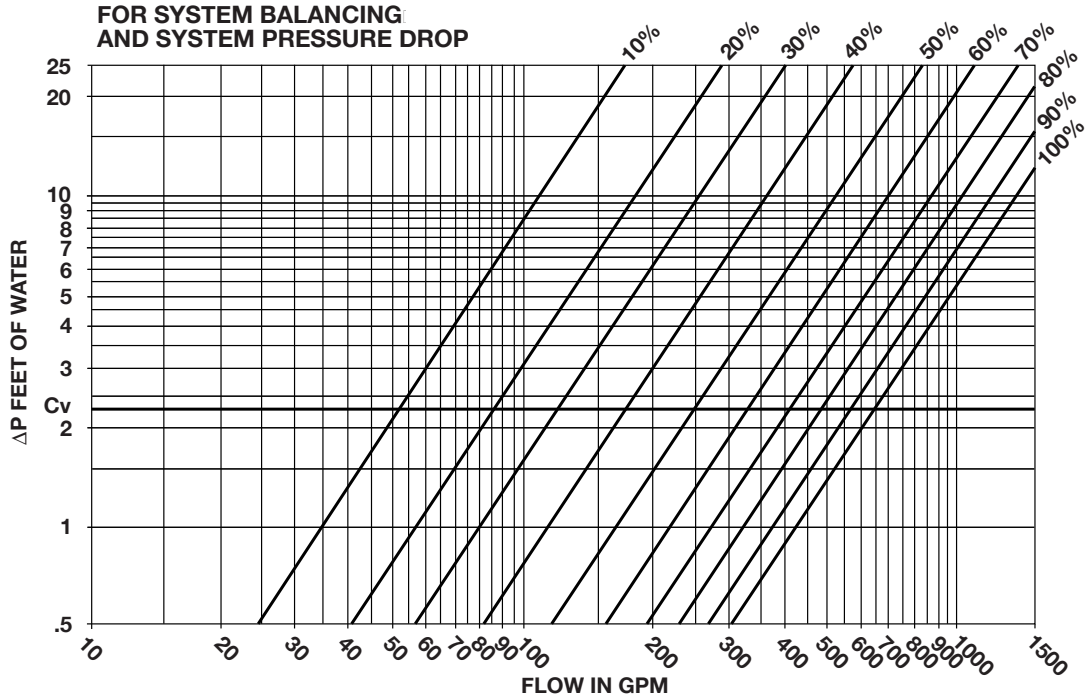

# Circuit Setter Plus Calibrated Balance Valve Performance Characteristics

Part No. 117115 (Old Design)  
 Part No. 117121 (Old Design)  
 Part No. 117473 (New Design)  
 Part No. 117479 (New Design)

Model No. CB-8F  
 Model No. CB-8G  
 Model No. CB-8F  
 Model No. CB-8G

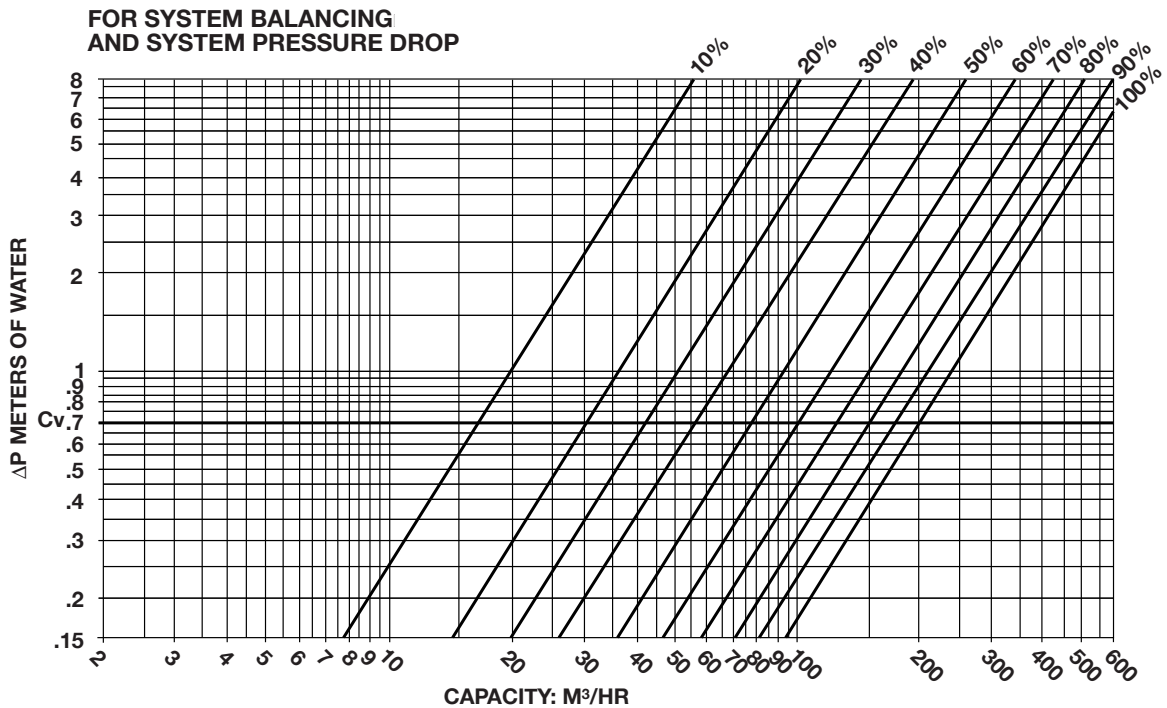
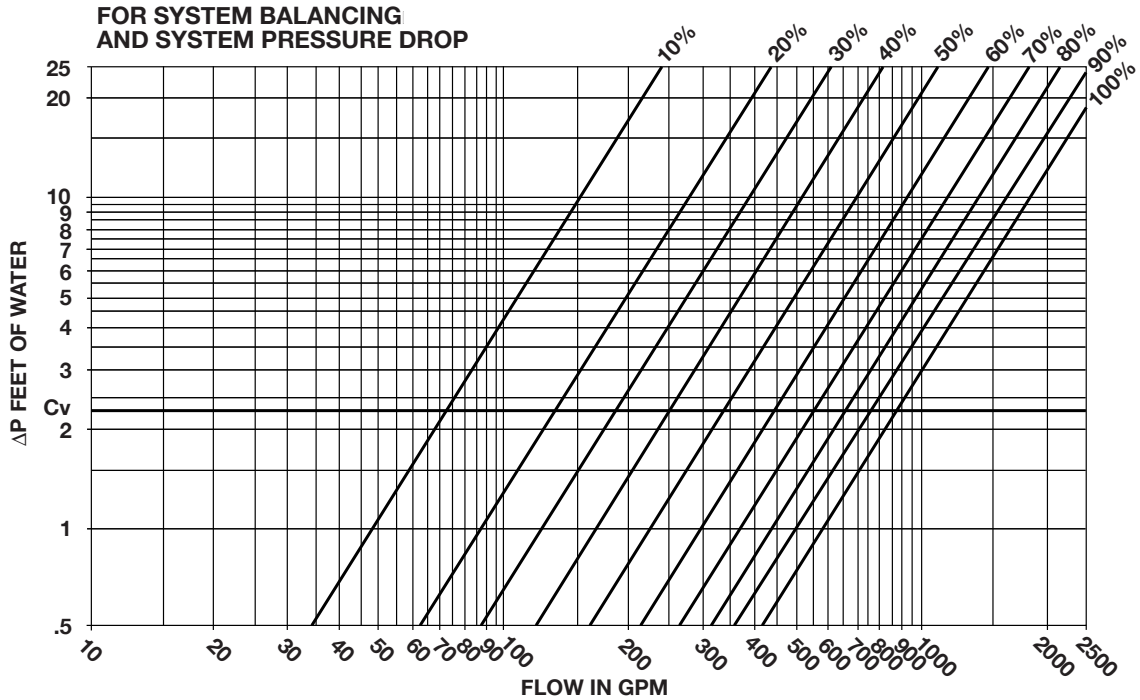

# Circuit Setter Plus Calibrated Balance Valve Performance Characteristics

Part No. 117420 (Old Design)	Model No. CB-10F
Part No. 117422 (Old Design)	Model No. CB-10G
Part No. 117474 (New Design)	Model No. CB-10F
Part No. 117480 (New Design)	Model No. CB-10G

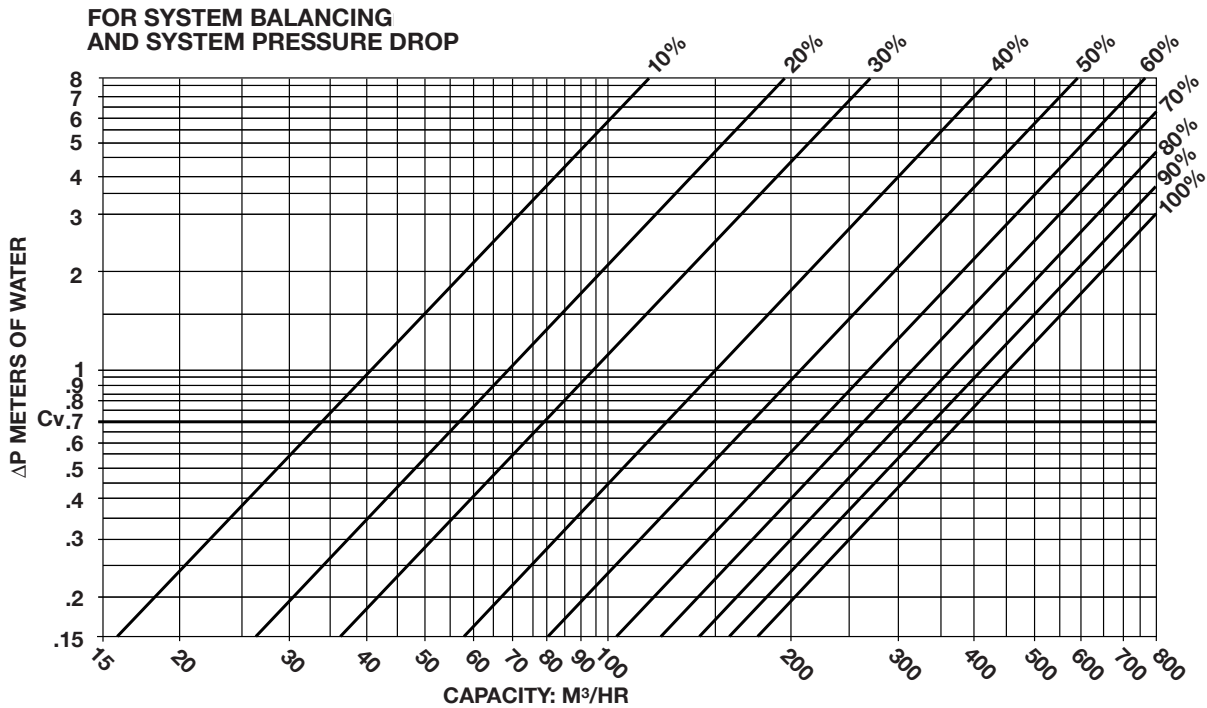
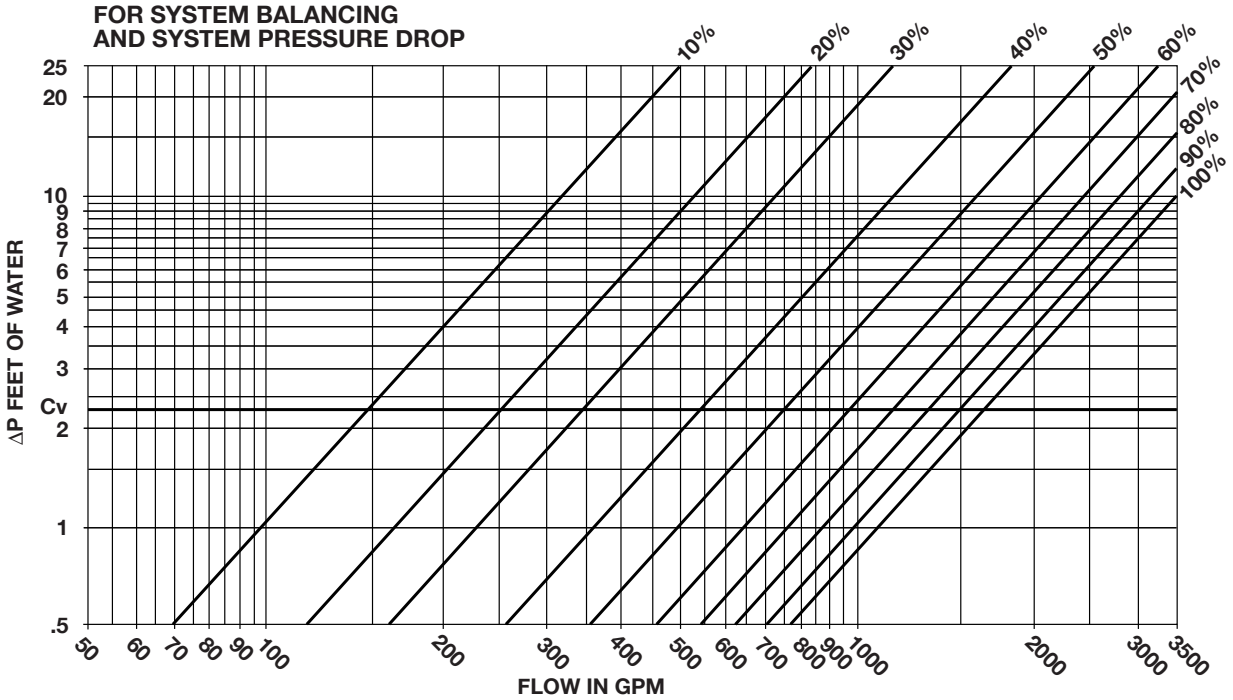

# Circuit Setter Plus Calibrated Balance Valve Performance Characteristics

Part No. 117421 (Old Design)	Model No. CB-12F
Part No. 117423 (Old Design)	Model No. CB-12G
Part No. 117475 (New Design)	Model No. CB-12F
Part No. 117481 (New Design)	Model No. CB-12G

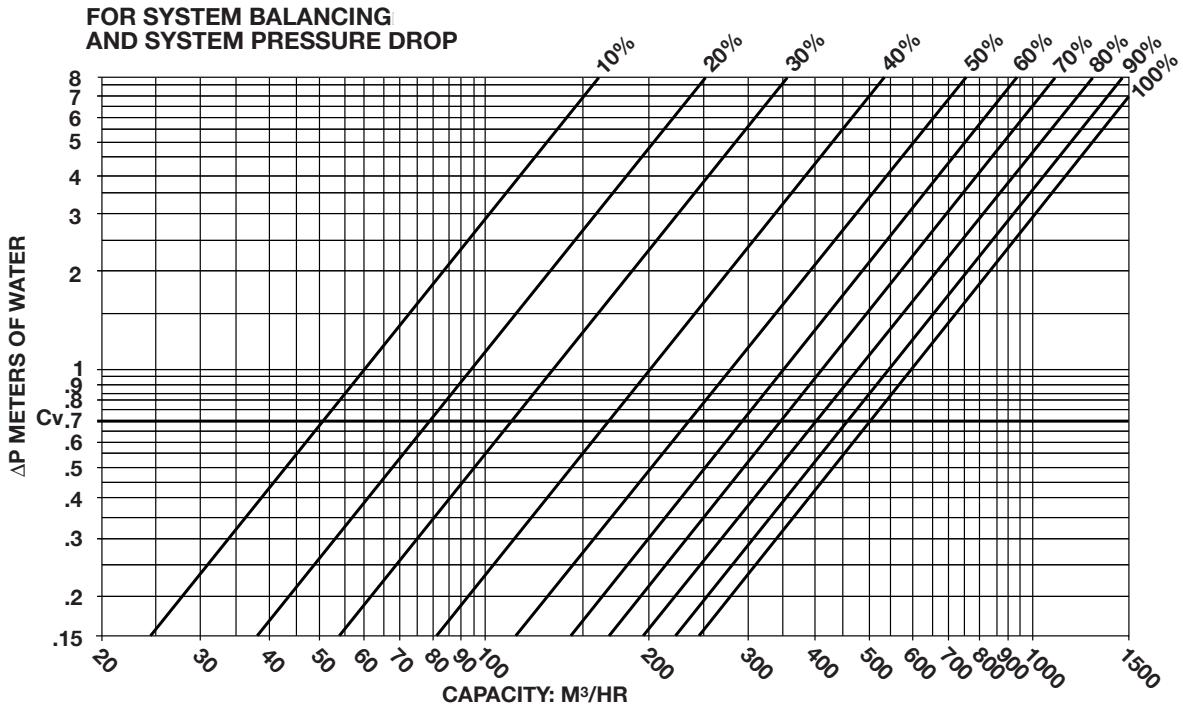
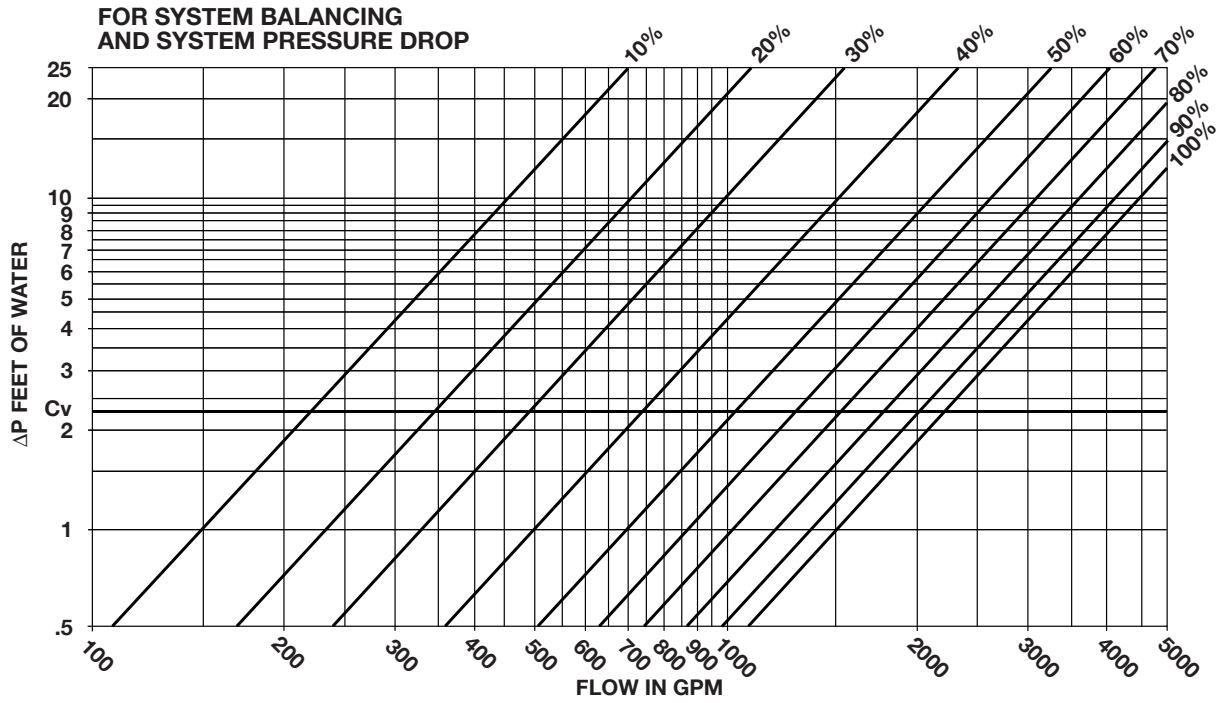

# Xylem |'zīləm|

- 1) The tissue in plants that brings water upward from the roots;
- 2) a leading global water technology company.

We're a global team unified in a common purpose: creating innovative solutions to meet our world's water needs. Developing new technologies that will improve the way water is used, conserved, and re-used in the future is central to our work. We move, treat, analyze, and return water to the environment, and we help people use water efficiently, in their homes, buildings, factories and farms. In more than 150 countries, we have strong, long-standing relationships with customers who know us for our powerful combination of leading product brands and applications expertise, backed by a legacy of innovation.

**For more information on how Xylem can help you, go to [www.xylem.com](http://www.xylem.com)**



Xylem Inc.  
8200 N. Austin Avenue  
Morton Grove, Illinois 60053  
Phone: (847) 966-3700  
Fax: (847) 965-8379  
[www.bellgossett.com](http://www.bellgossett.com)

Bell & Gossett is a trademark of Xylem Inc. or one of its subsidiaries.  
© 2015 Xylem Inc. G10091E June 2015