

CURVES
B-261D

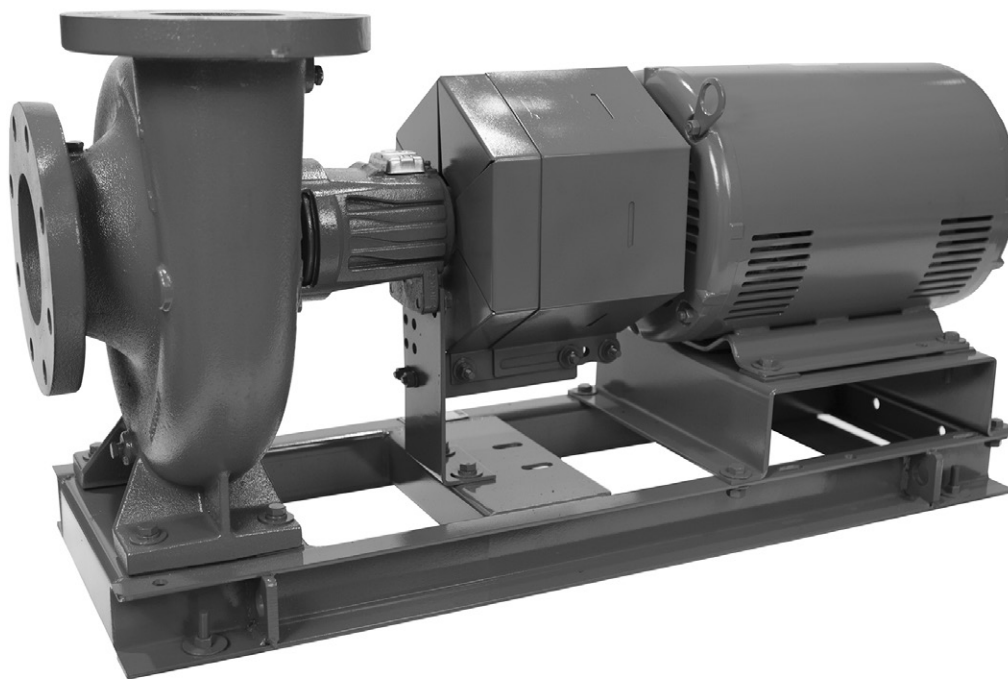

Series e-1510

BASE MOUNTED CENTRIFUGAL PUMP PERFORMANCE CURVES - 60 HZ

TABLE OF CONTENTS

Useful Pump Formulas	2
1800 RPM PUMP CURVES	
A - Size Curves	3
B - Size Curves	9
E - Size Curves	13
G - Size Curves	16
1200 RPM PUMP CURVES	
A - Size Curves	19
B - Size Curves	25
E - Size Curves	29
G - Size Curves	32
3600 RPM PUMP CURVES	
A - Size Curves	35
B - Size Curves	39
E - Size Curves	42

USEFUL PUMP FORMULAS

$$\begin{aligned} \text{Pressure (PSI)} &= \frac{\text{Head (Feet)} \times \text{Specific Gravity}}{2.31} \\ \text{Head (Feet)} &= \frac{\text{Pressure (PSI)} \times 2.31}{\text{Specific Gravity}} \\ \text{Vacuum (Inches of Mercury)} &= \frac{\text{Dynamic Suction Lift (Feet)} \times .883}{\text{Specific Gravity}} \\ \text{Horsepower (Brake)} &= \frac{\text{GPM} \times \text{Head (Feet)} \times \text{Specific Gravity}}{3960 \times \text{Pump Efficiency}} \\ \text{Horsepower (Water)} &= \frac{\text{GPM} \times \text{Head (Feet)} \times \text{Specific Gravity}}{3960} \\ \text{Efficiency (Pump)} &= \frac{\text{Horsepower (Water)}}{\text{Horsepower (Brake)}} \times 100 \text{ Per Cent} \\ \text{NPSH (Available)} &= \text{Positive Factors} - \text{Negative Factors} \end{aligned}$$

Affinity Laws: Effect of change of speed or impeller diameter on centrifugal pumps.

	GPM Capacity	Ft. Head	BHP
Impeller Diameter Change	$Q_2 = \frac{D_2}{D_1} Q_1$	$H_2 = \left(\frac{D_2}{D_1}\right)^2 H_1$	$P_2 = \left(\frac{D_2}{D_1}\right)^3 P_1$
Speed Change	$Q_2 = \frac{RPM_2}{RPM_1} Q_1$	$H_2 = \left(\frac{RPM_2}{RPM_1}\right)^2 H_1$	$P_2 = \left(\frac{RPM_2}{RPM_1}\right)^3 P_1$

Where Q = GPM, H = Head, P = BHP, D = Impeller Dia., RPM = Pump Speed

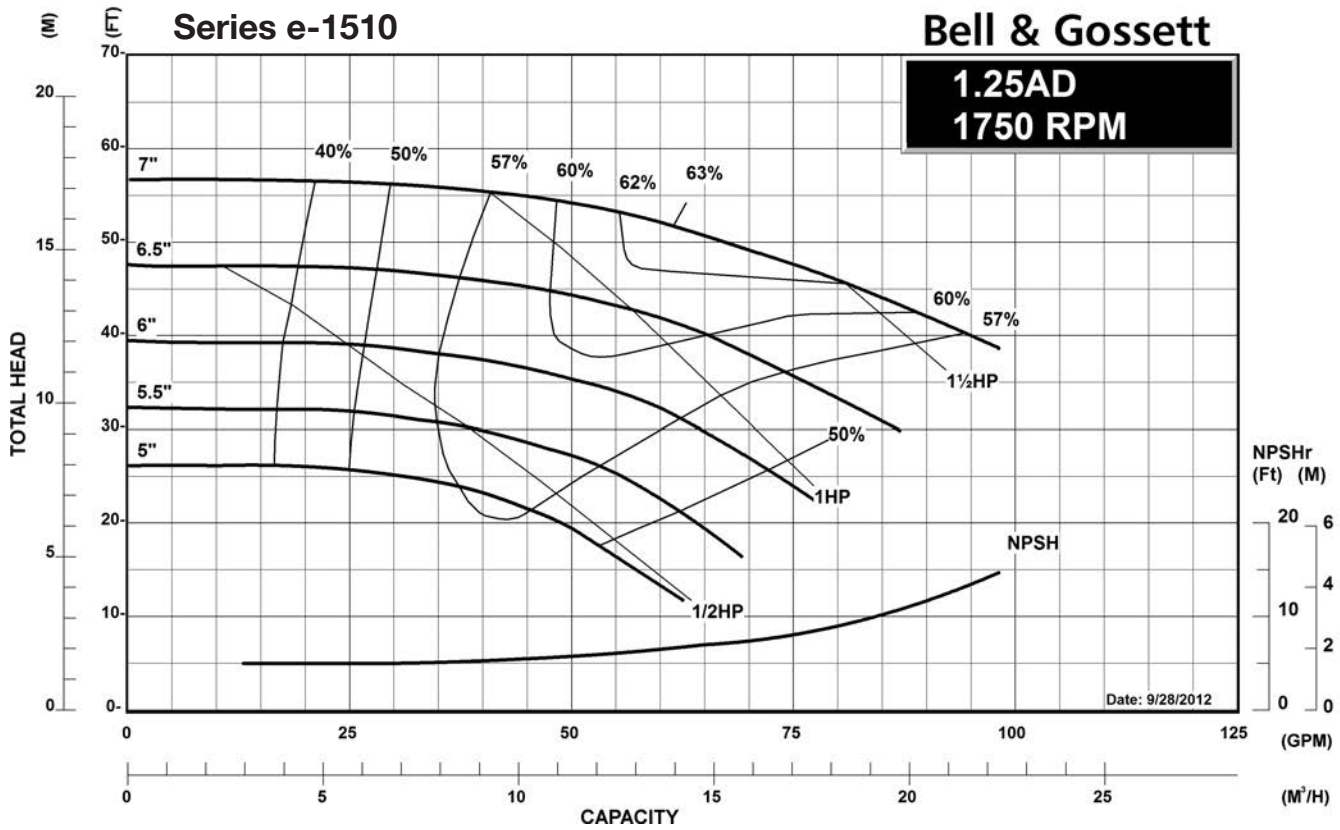
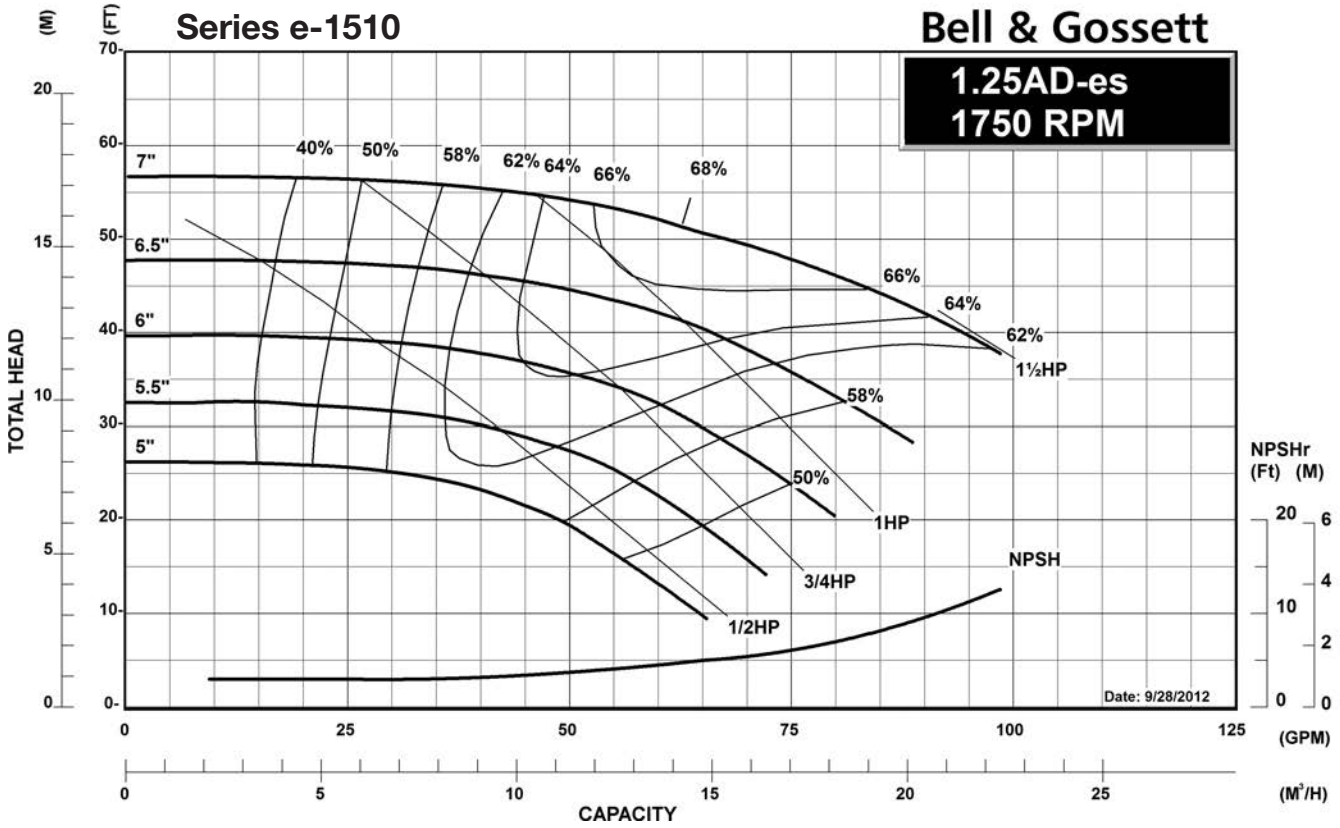

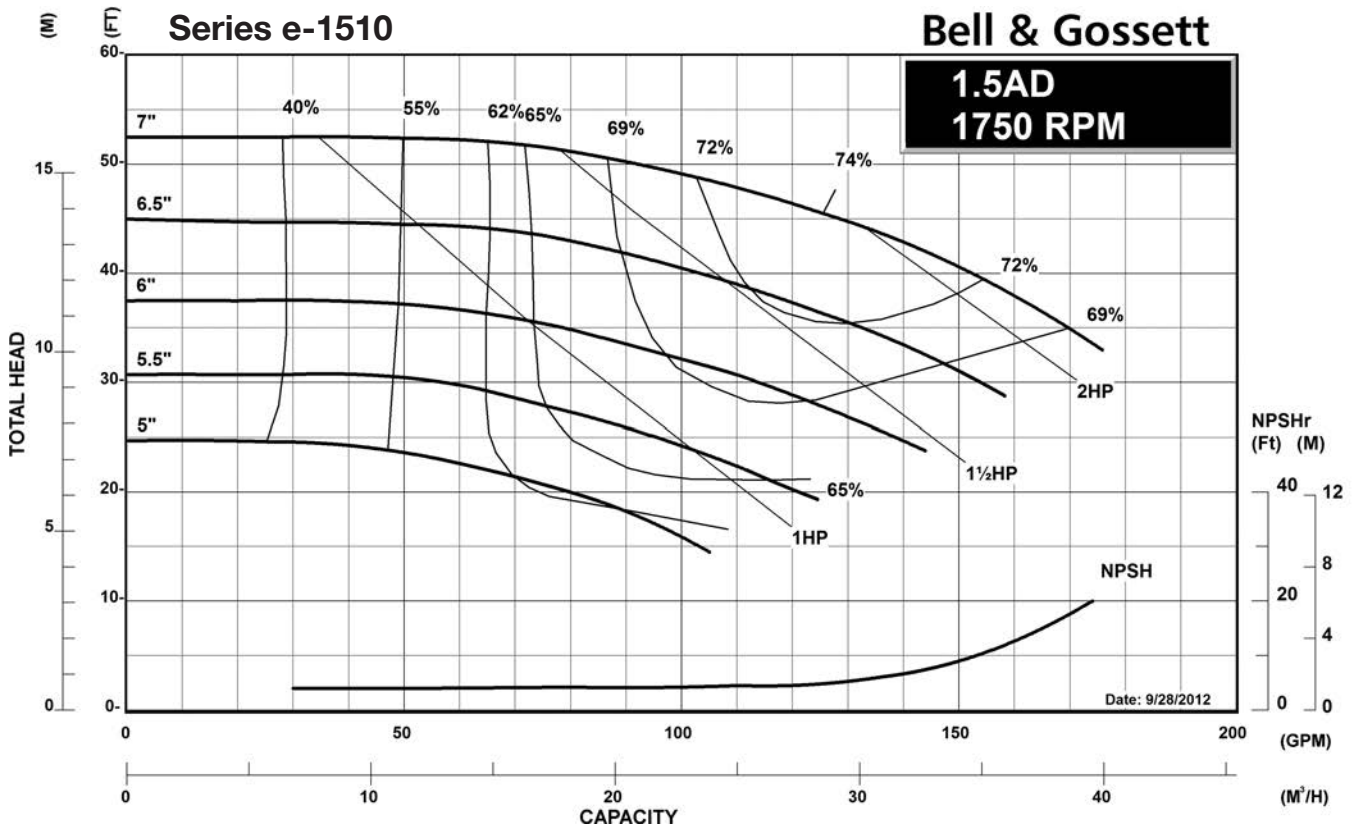
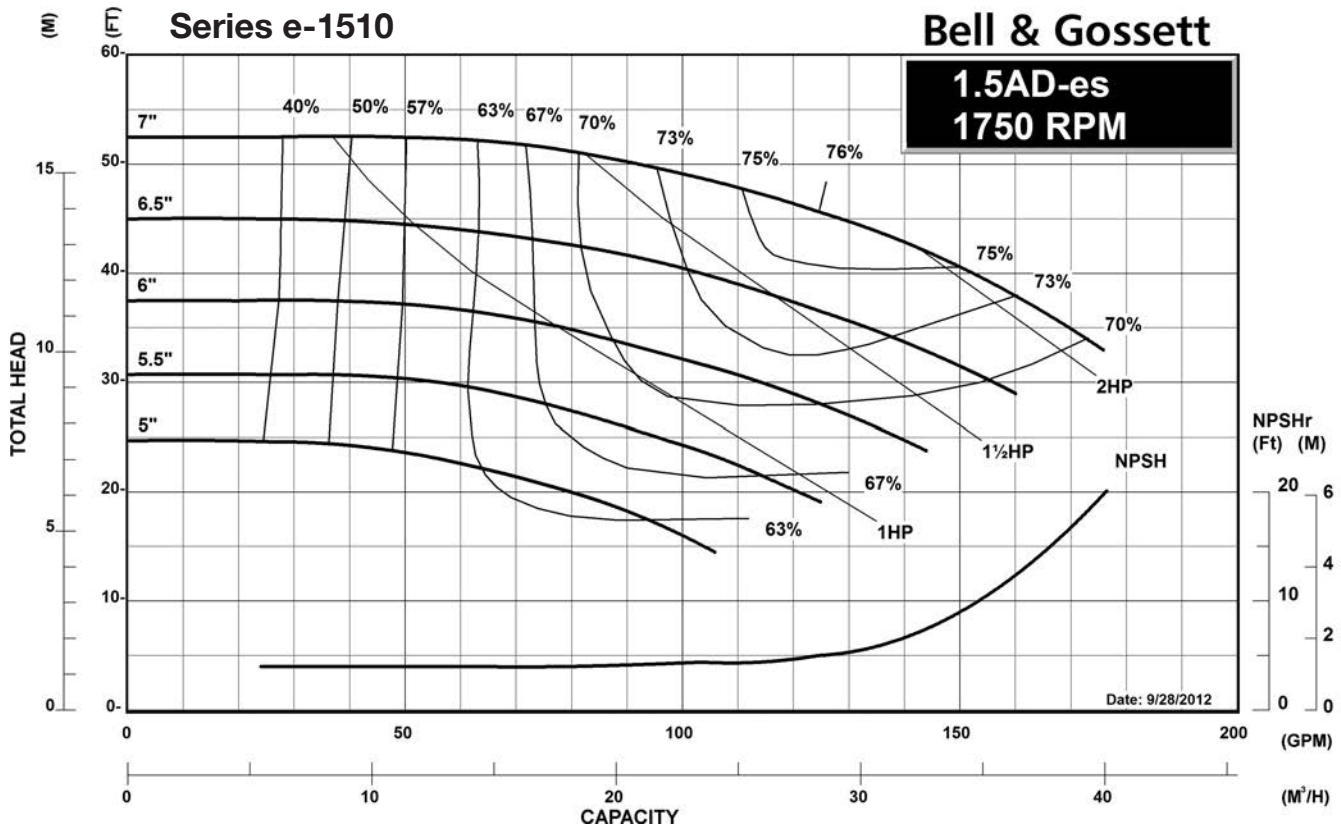

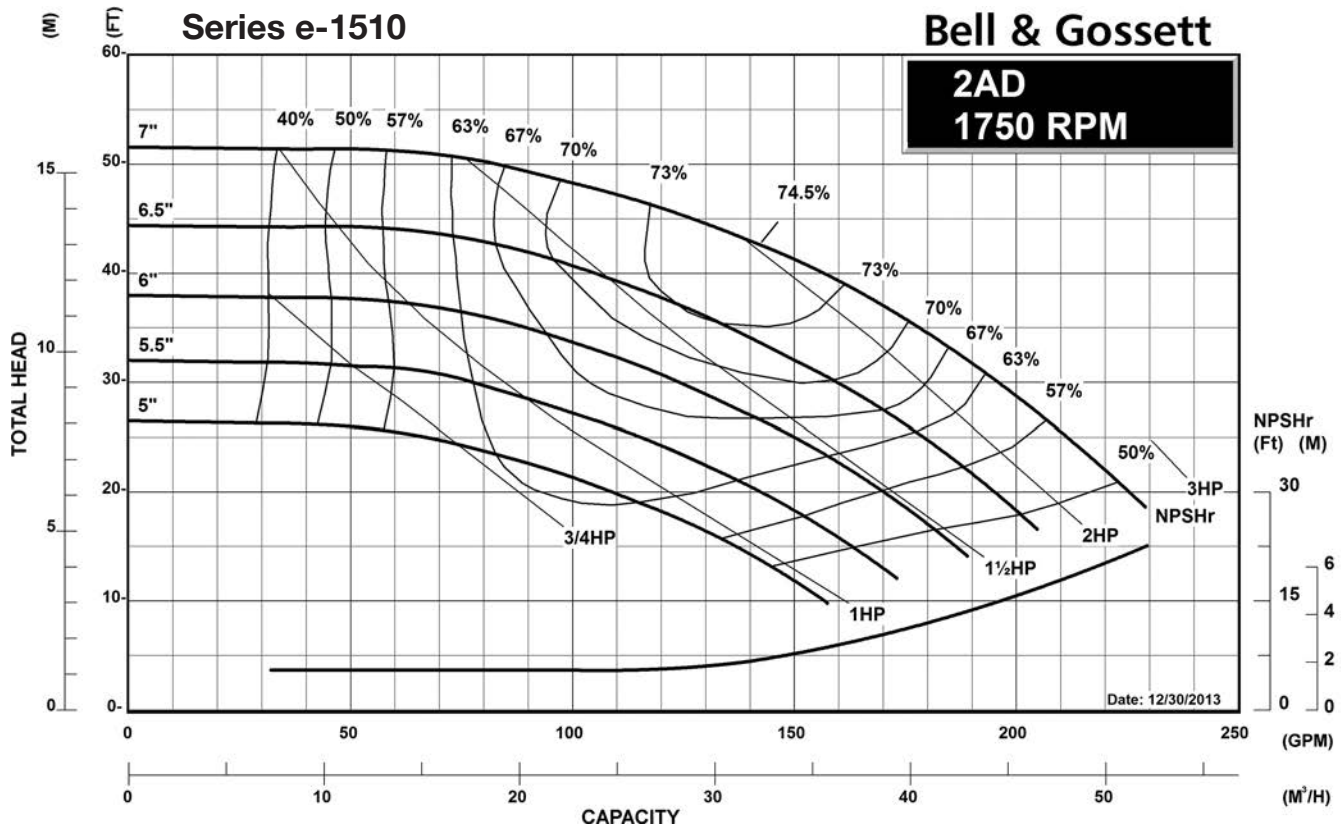
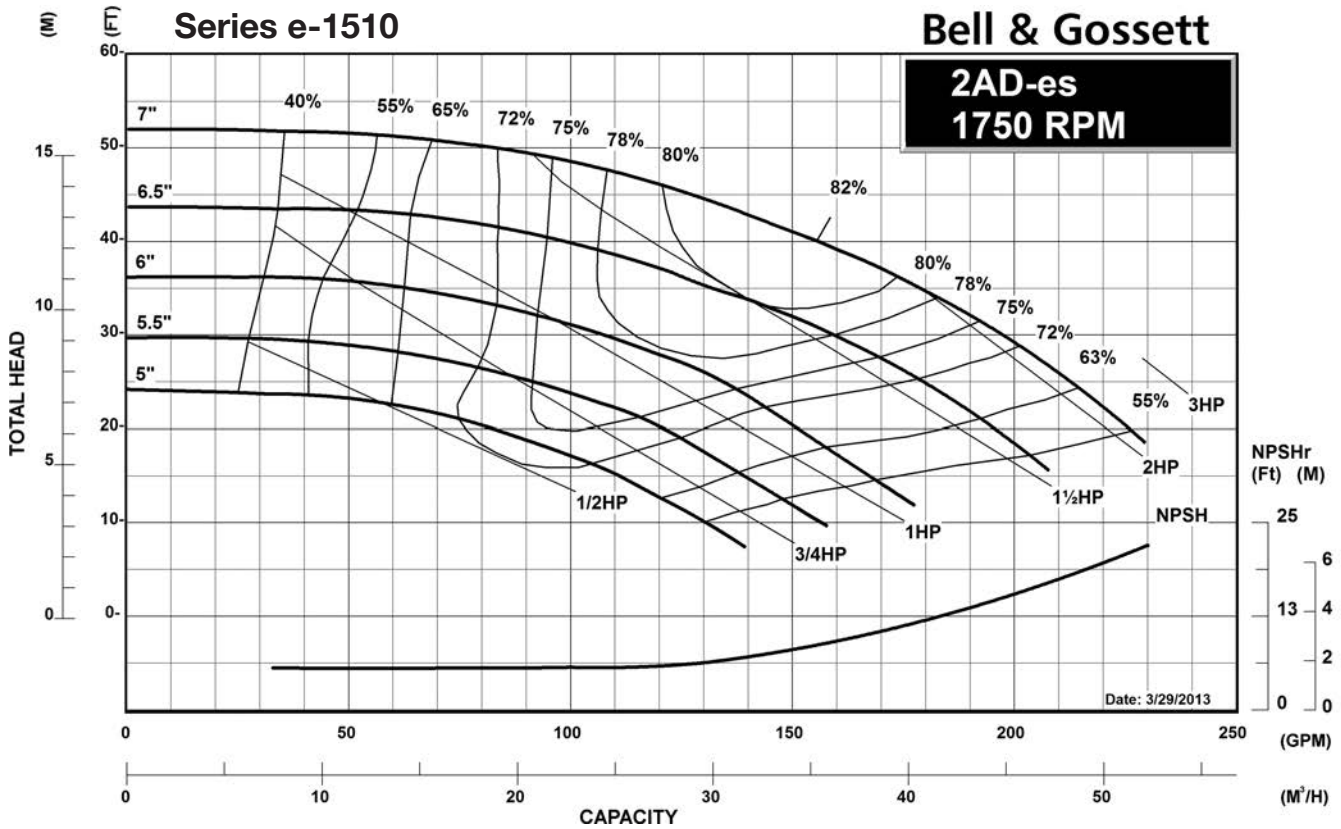

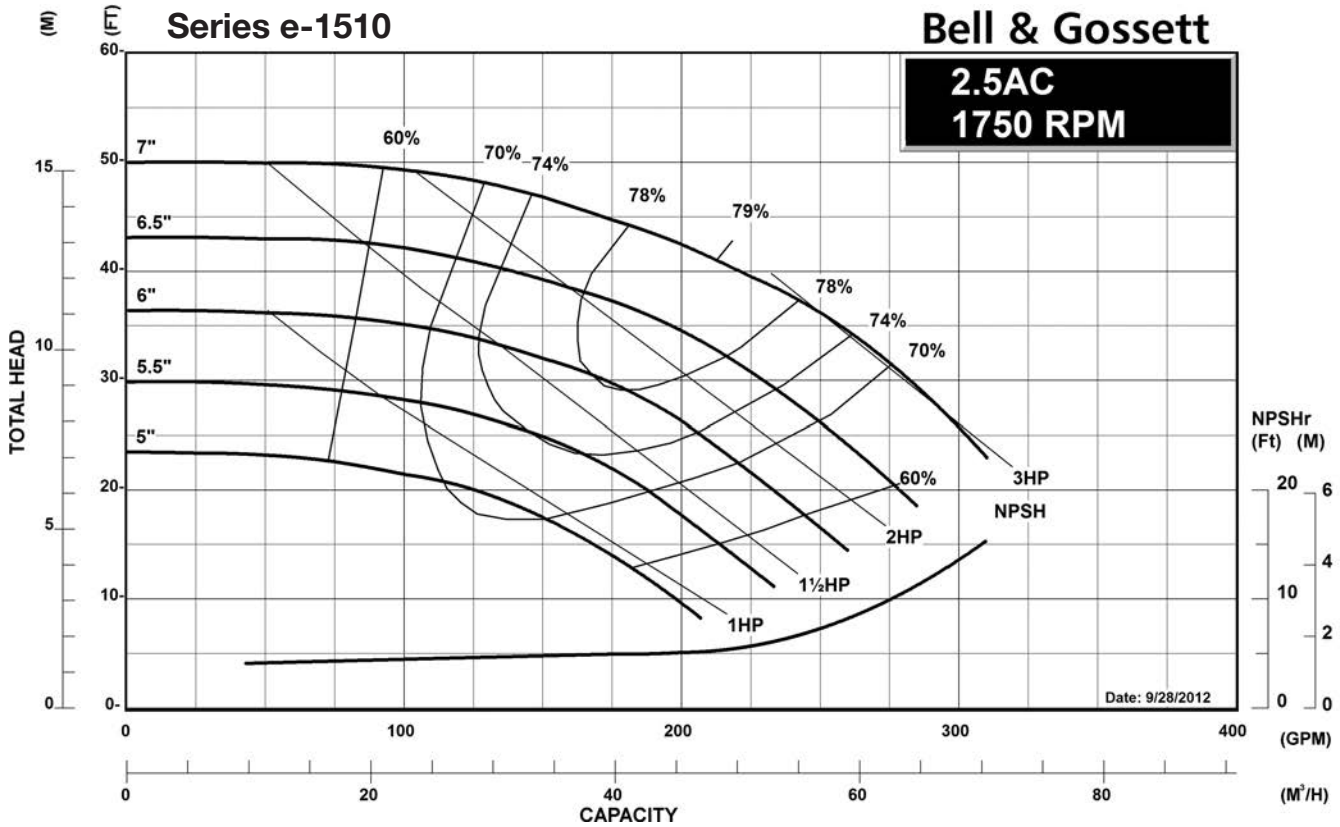
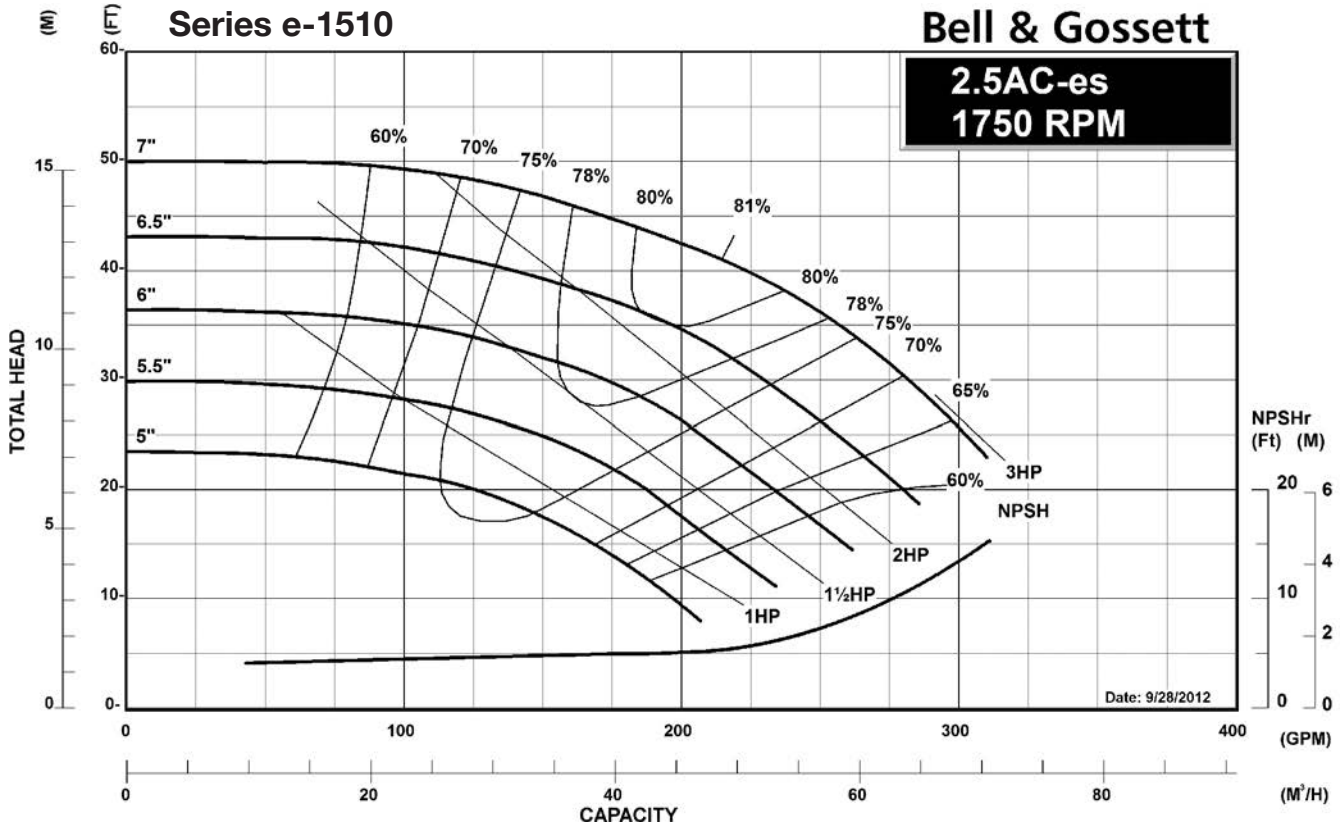

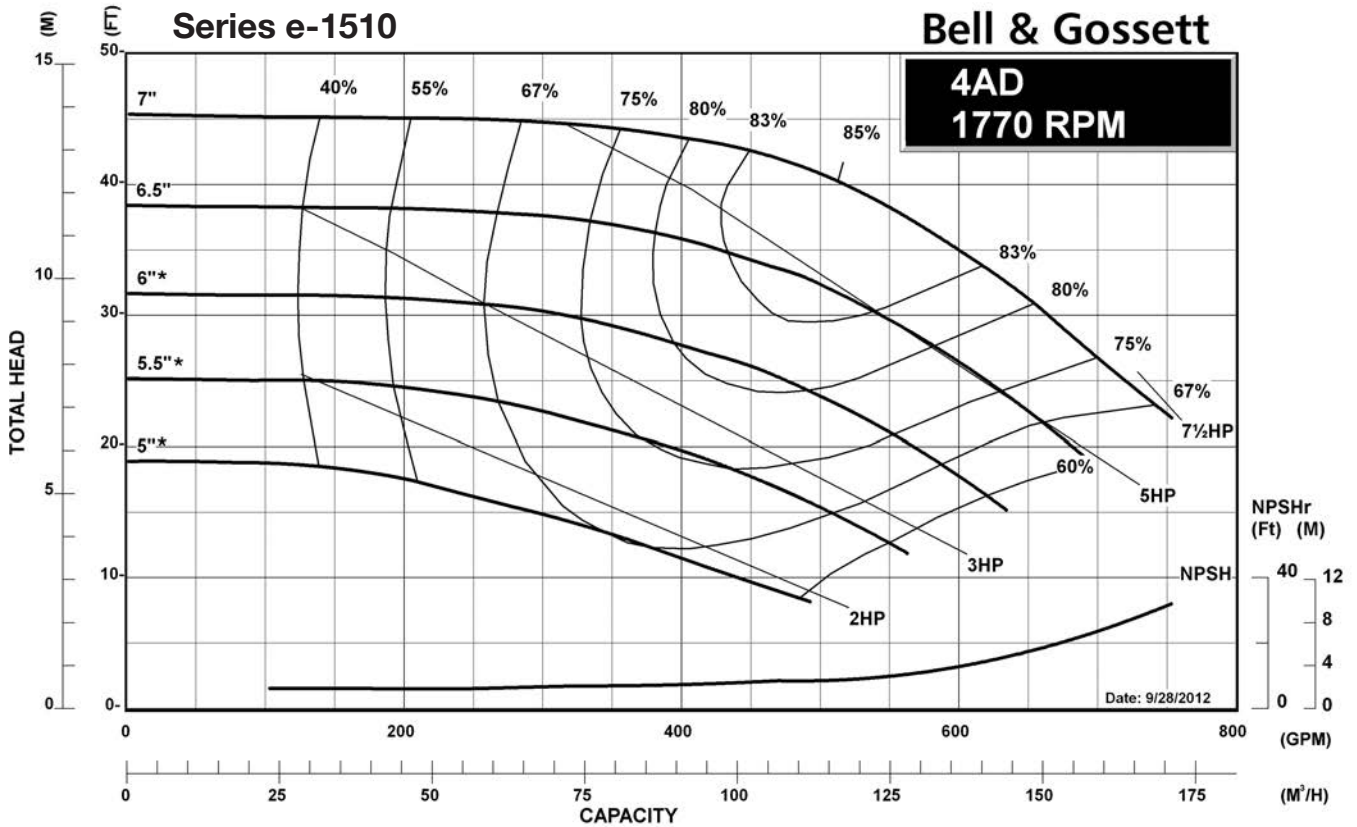
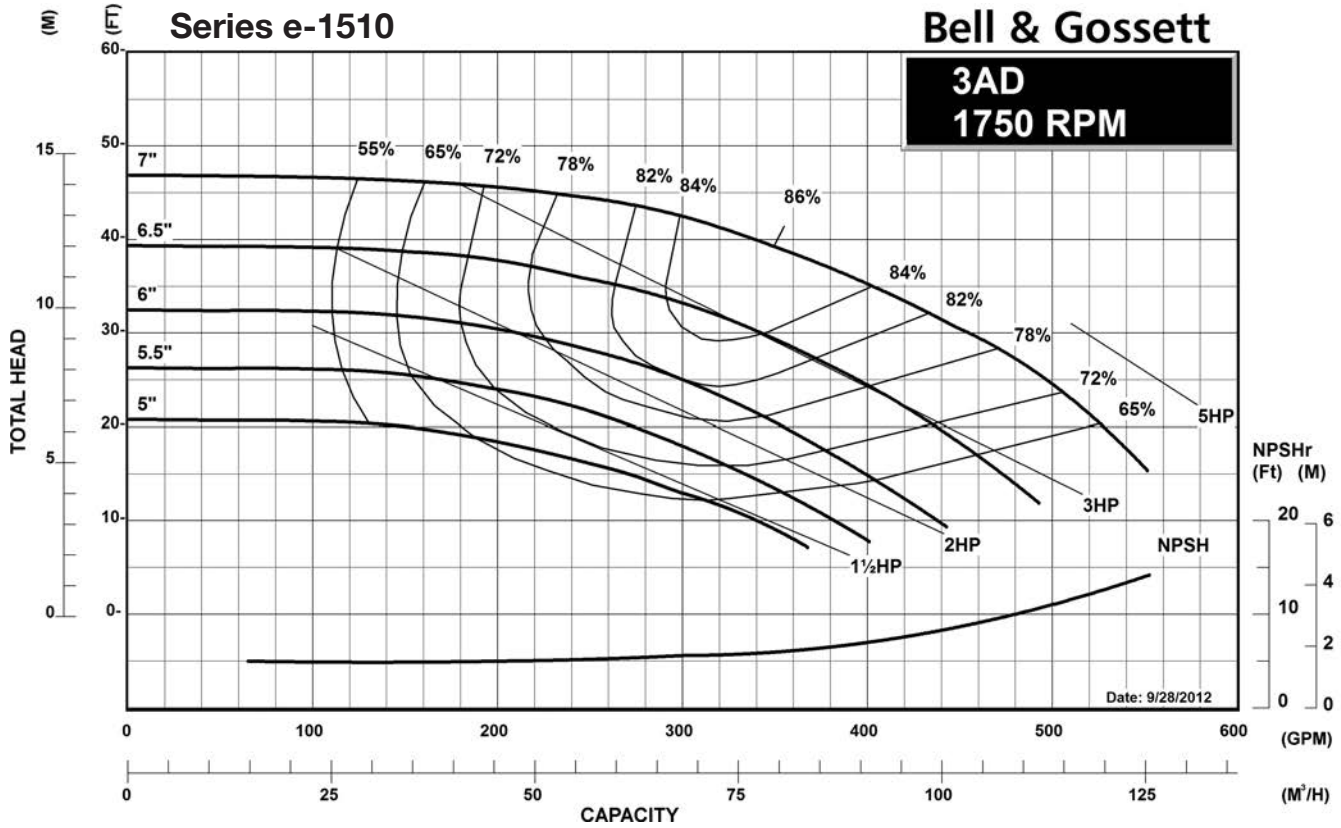

* 6" and below requires oversized diameter and angle trim. See manual.

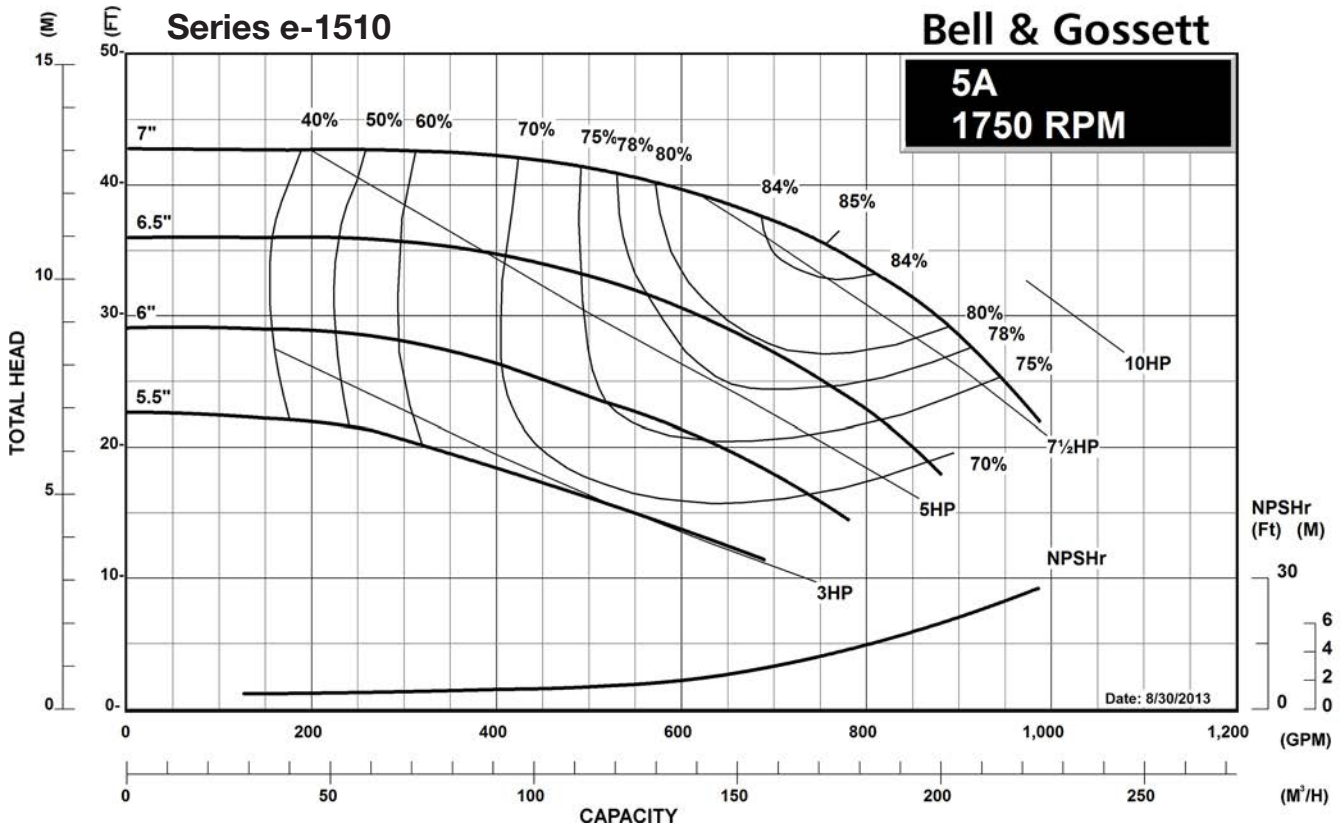

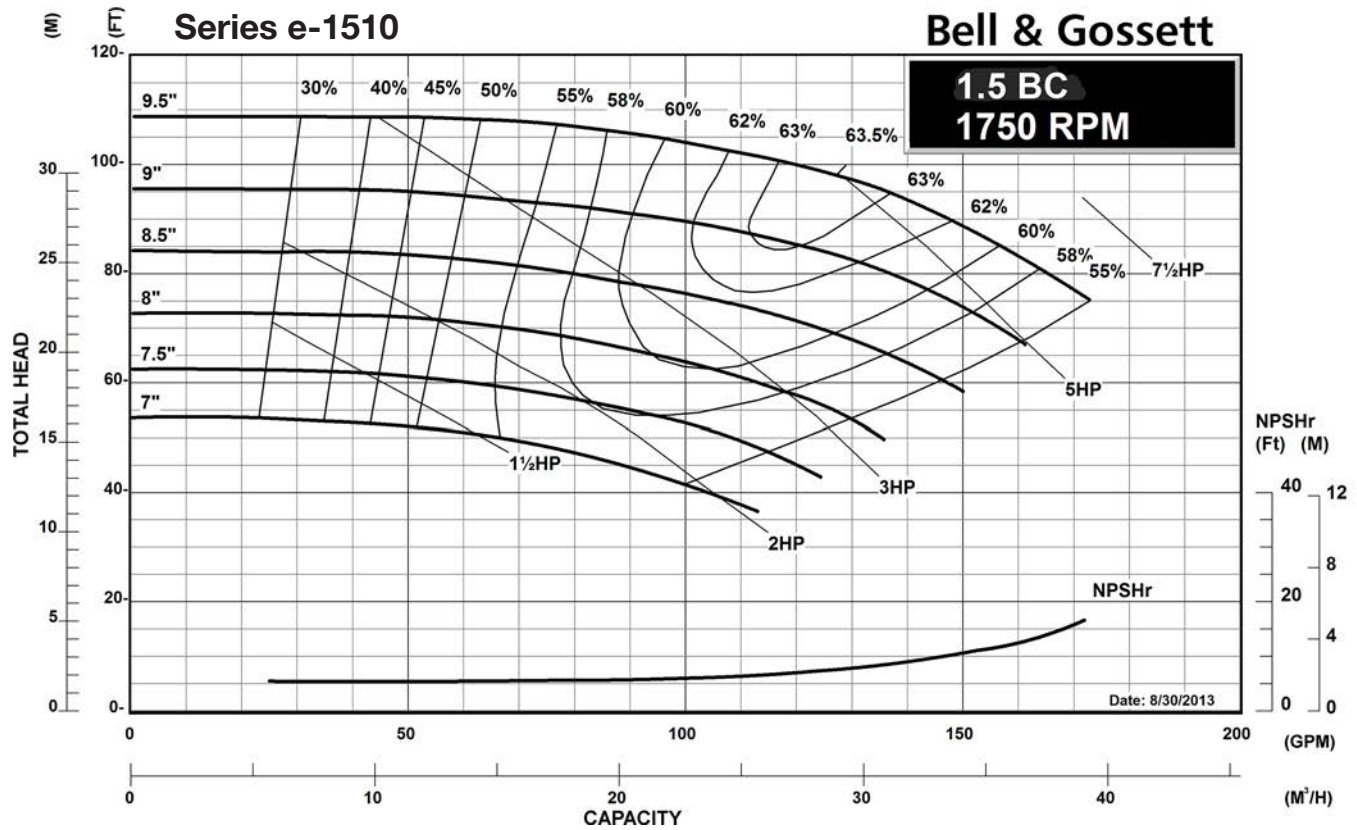
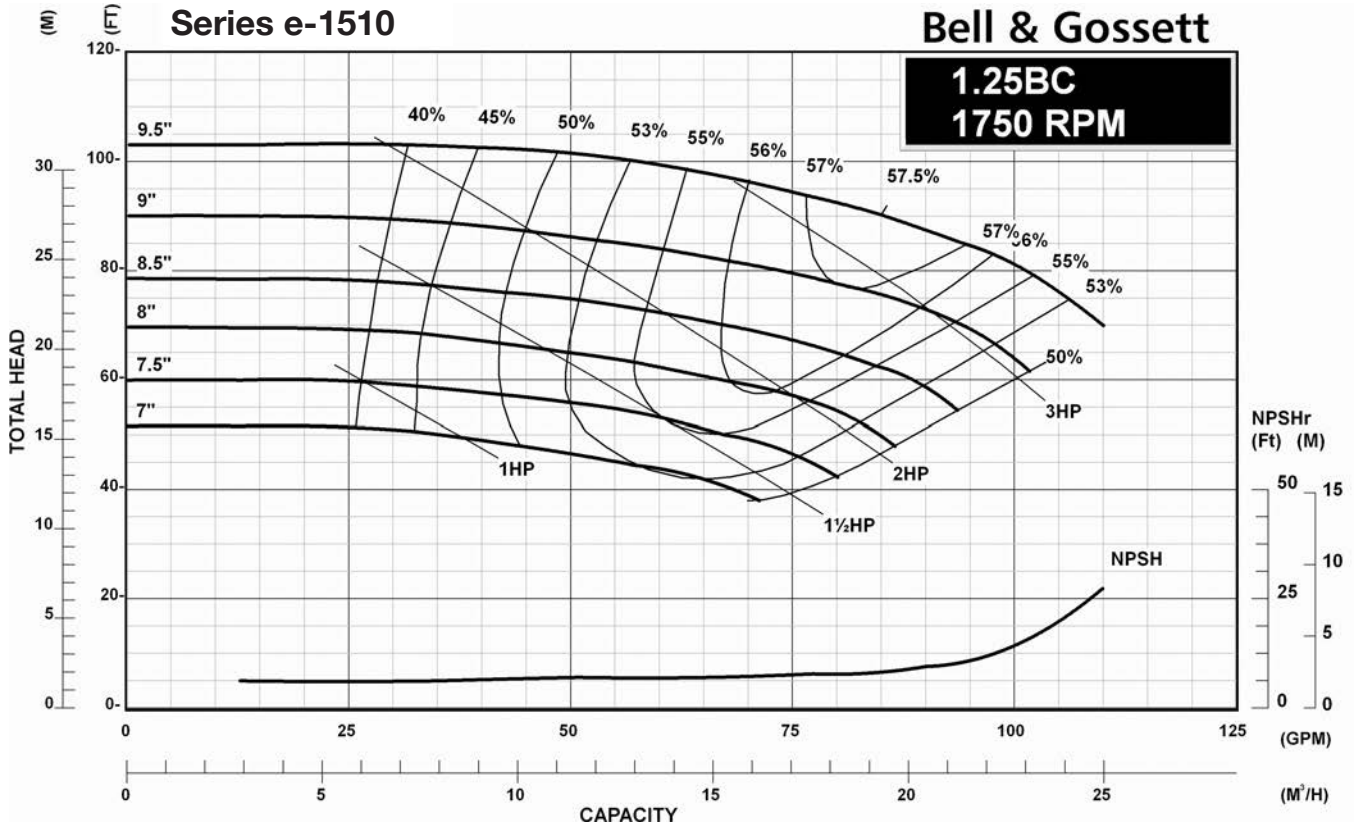

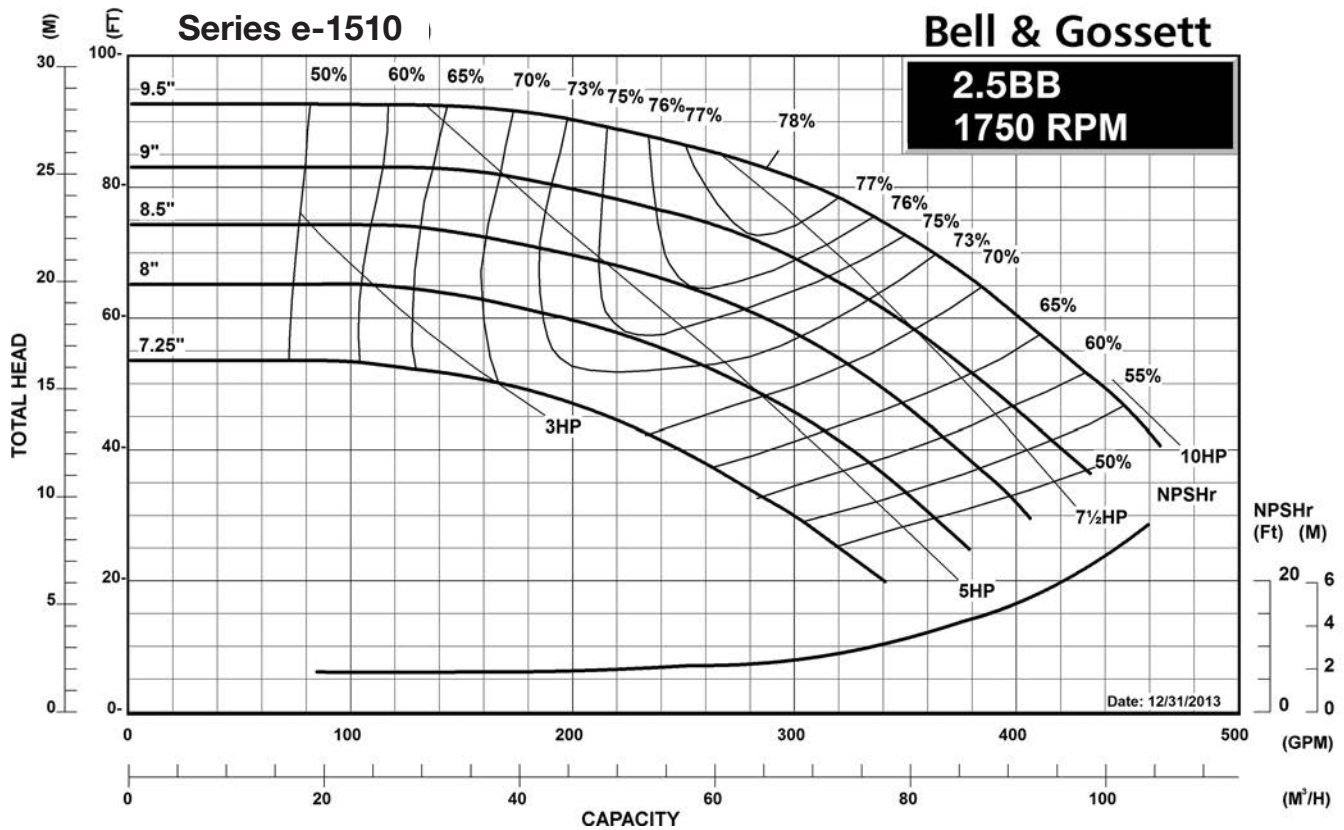
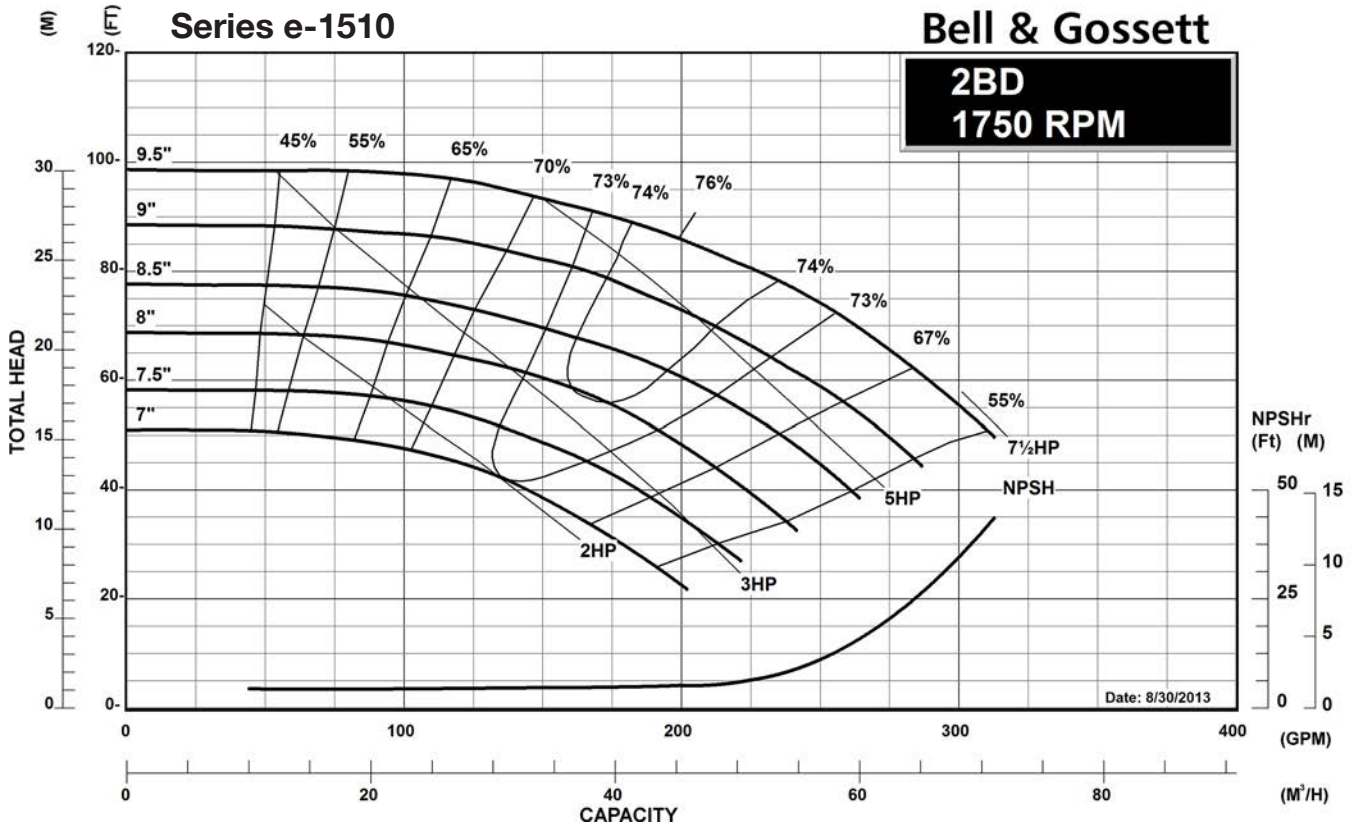

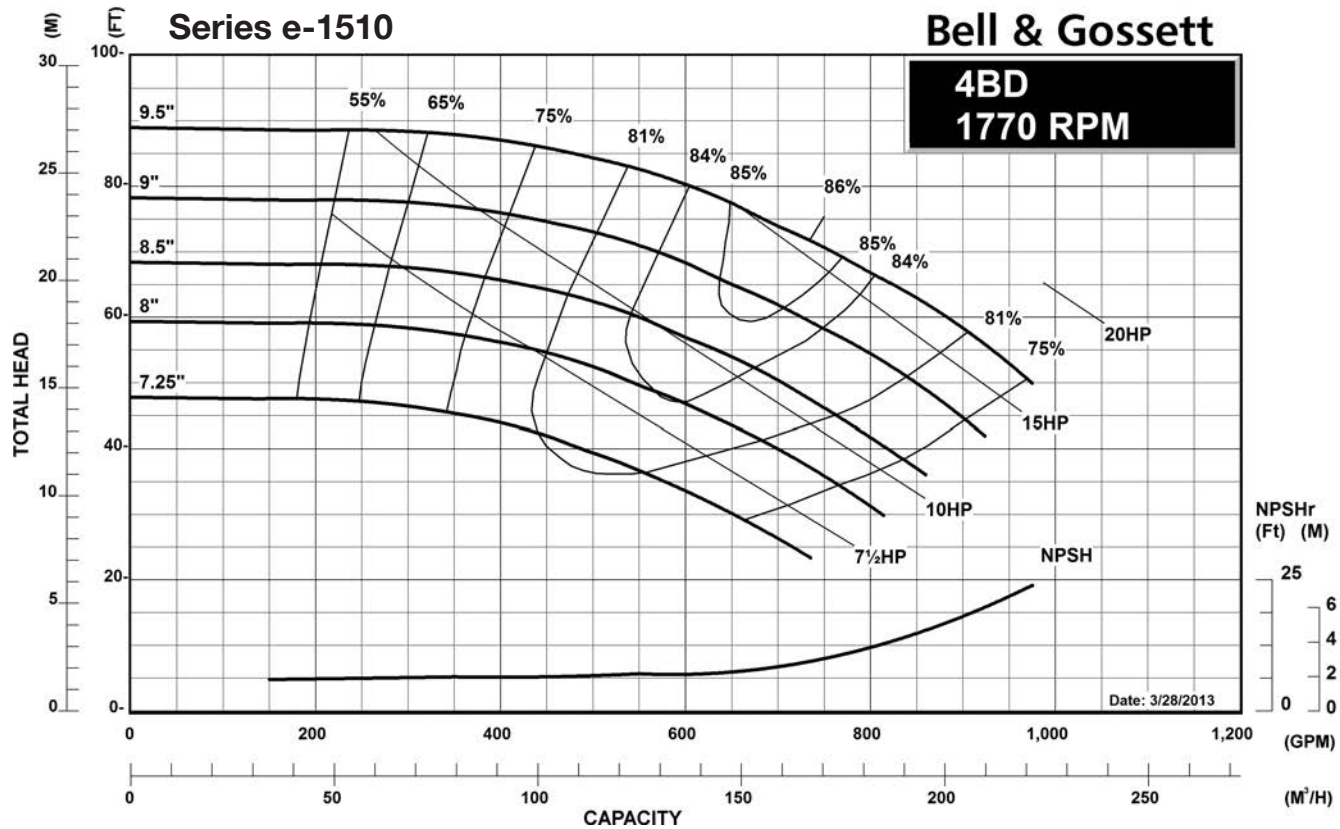
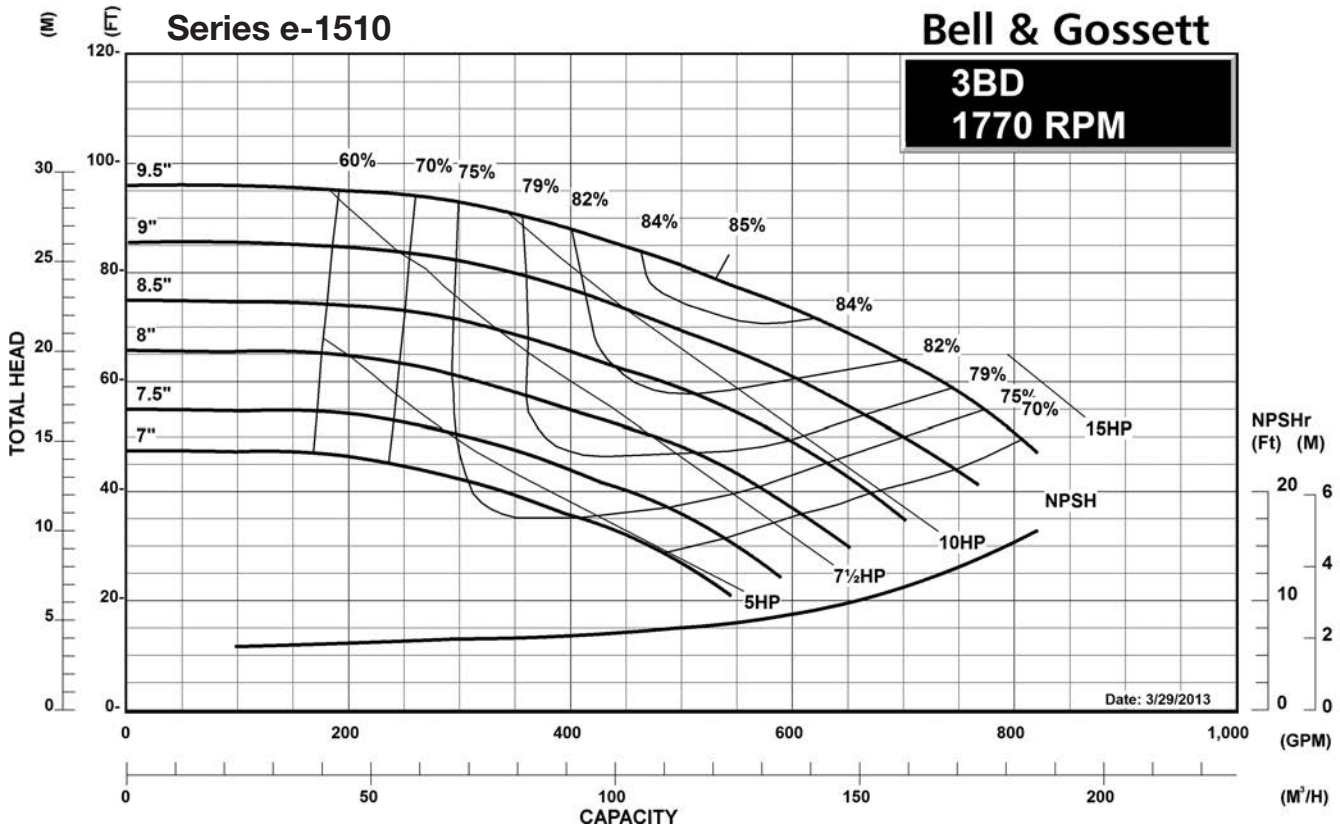

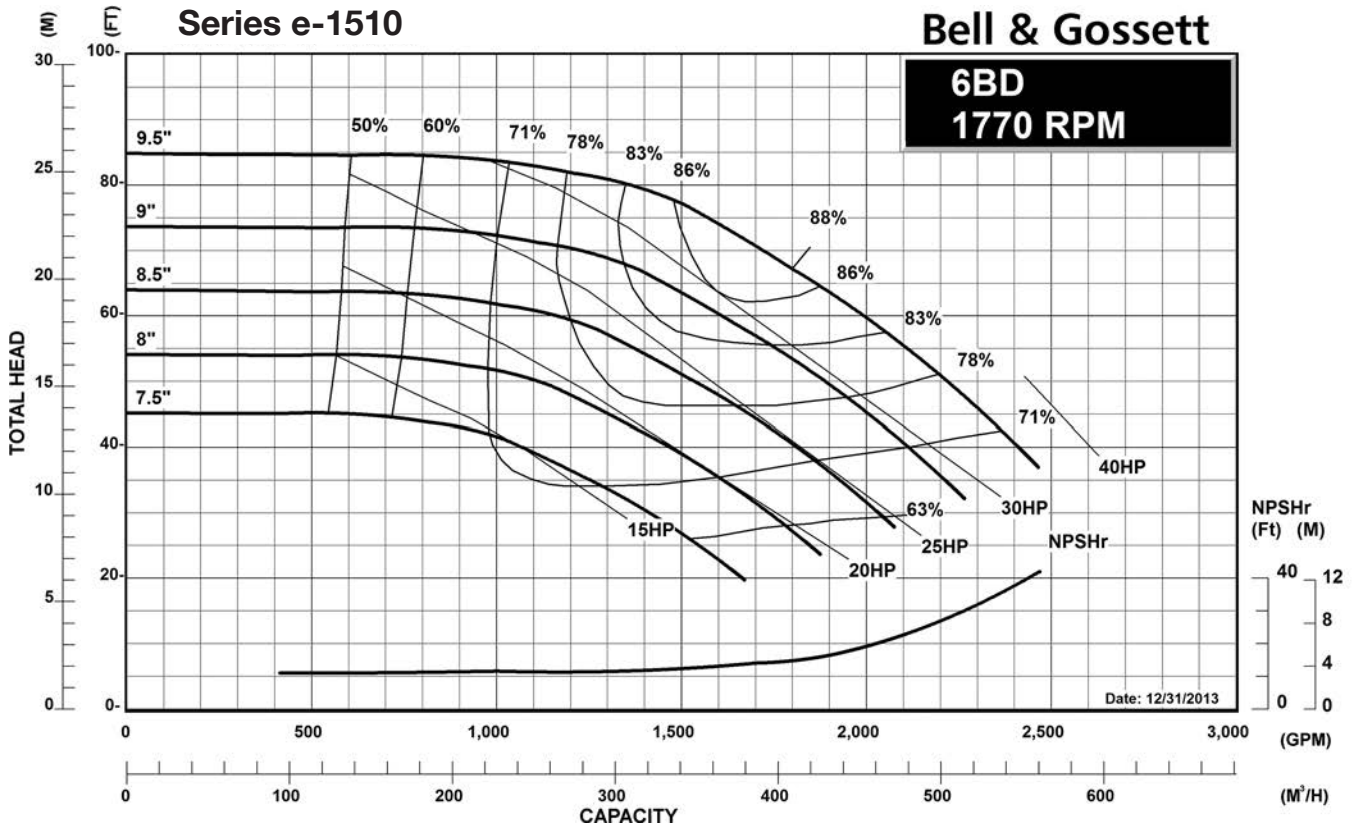
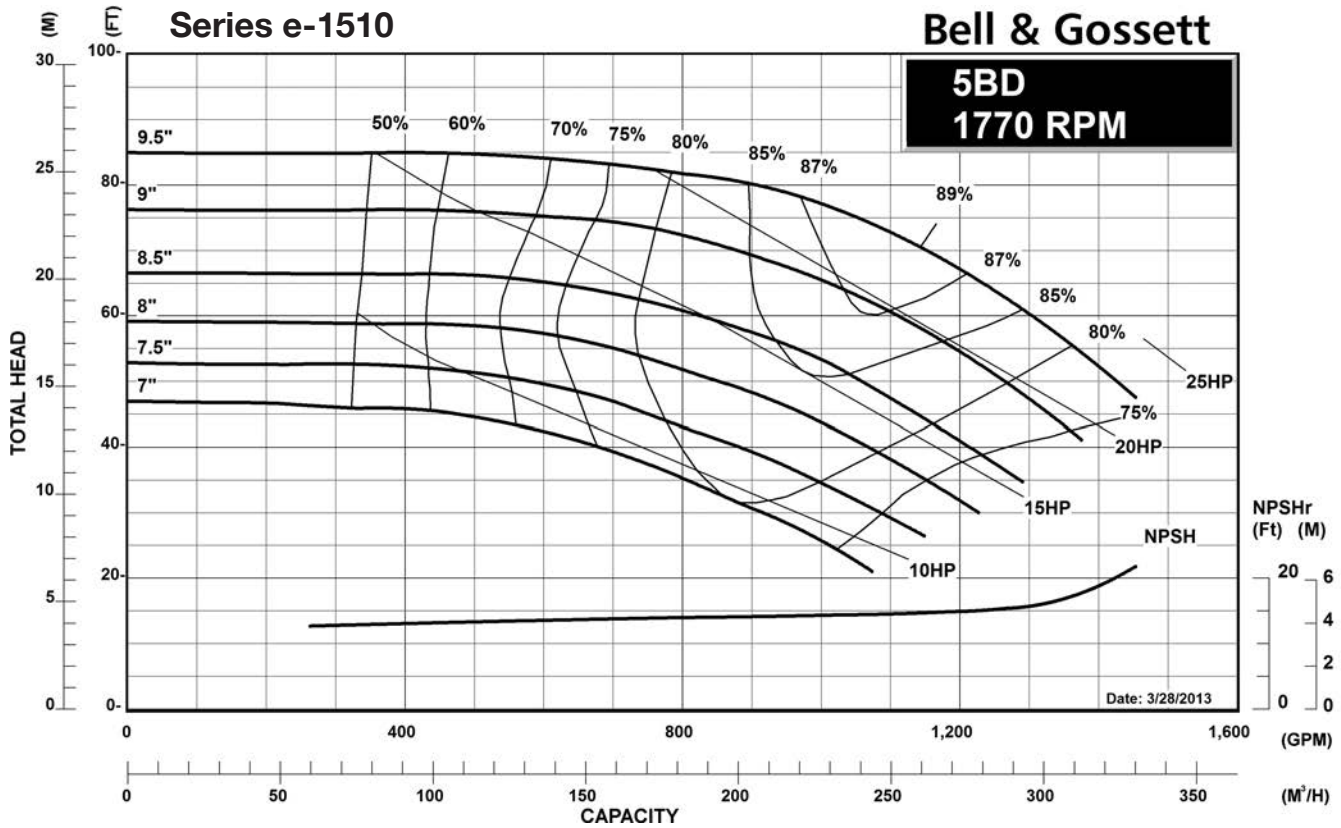

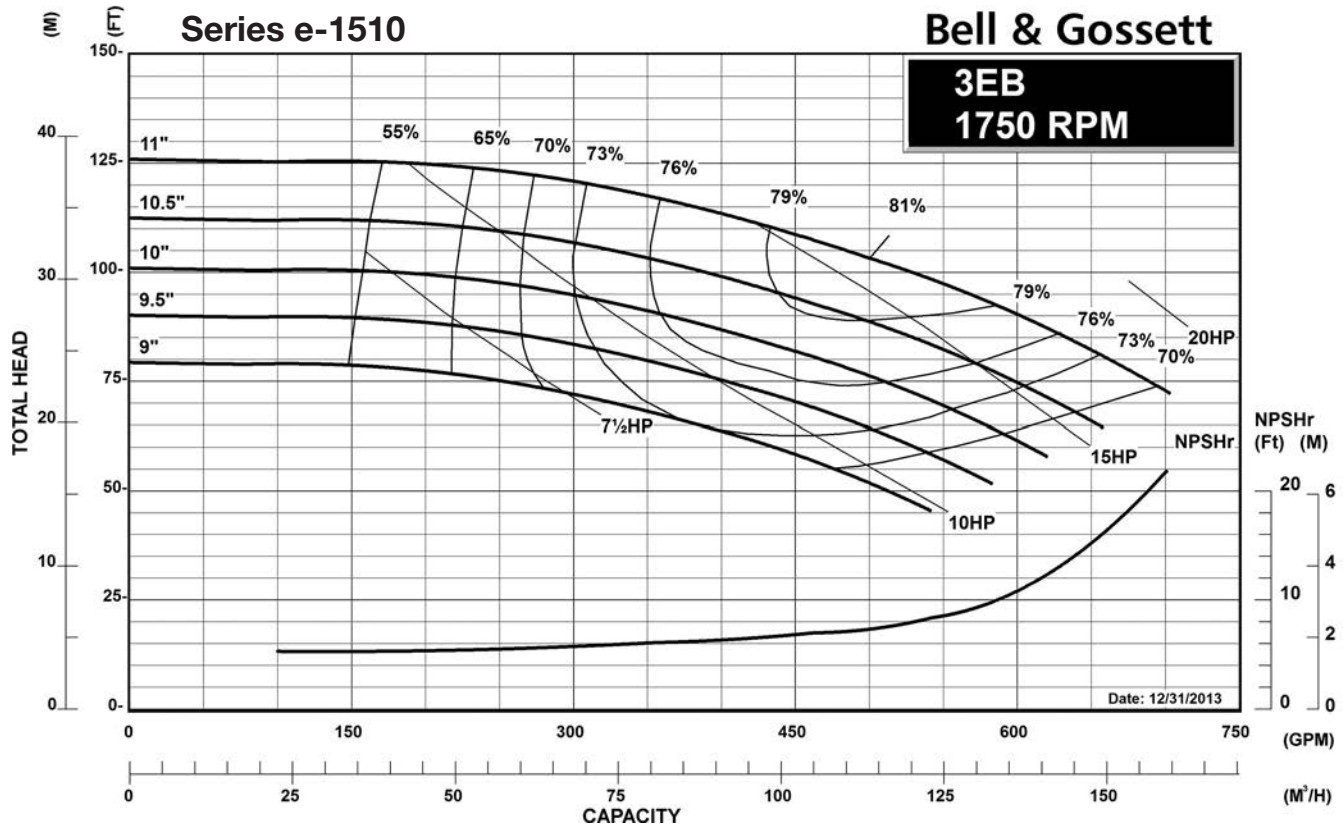
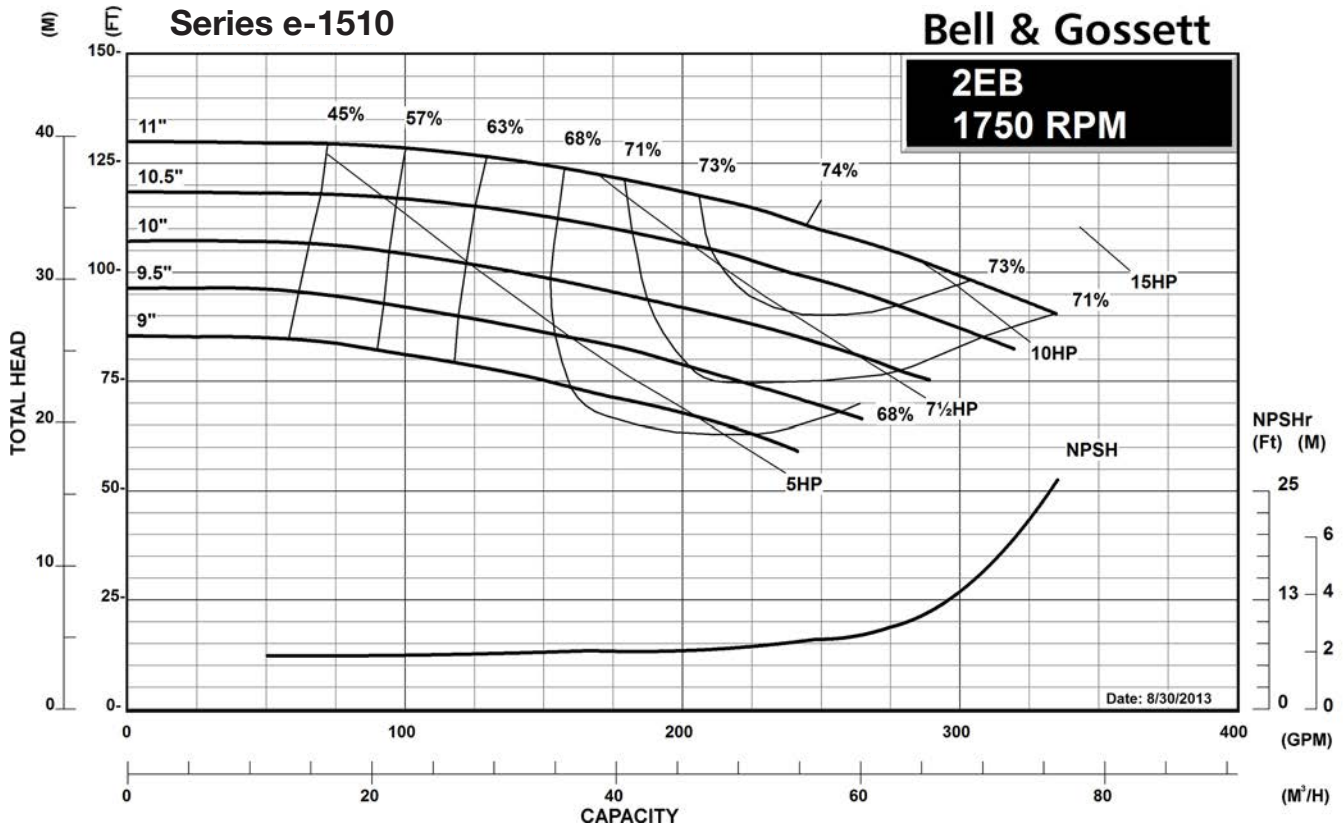

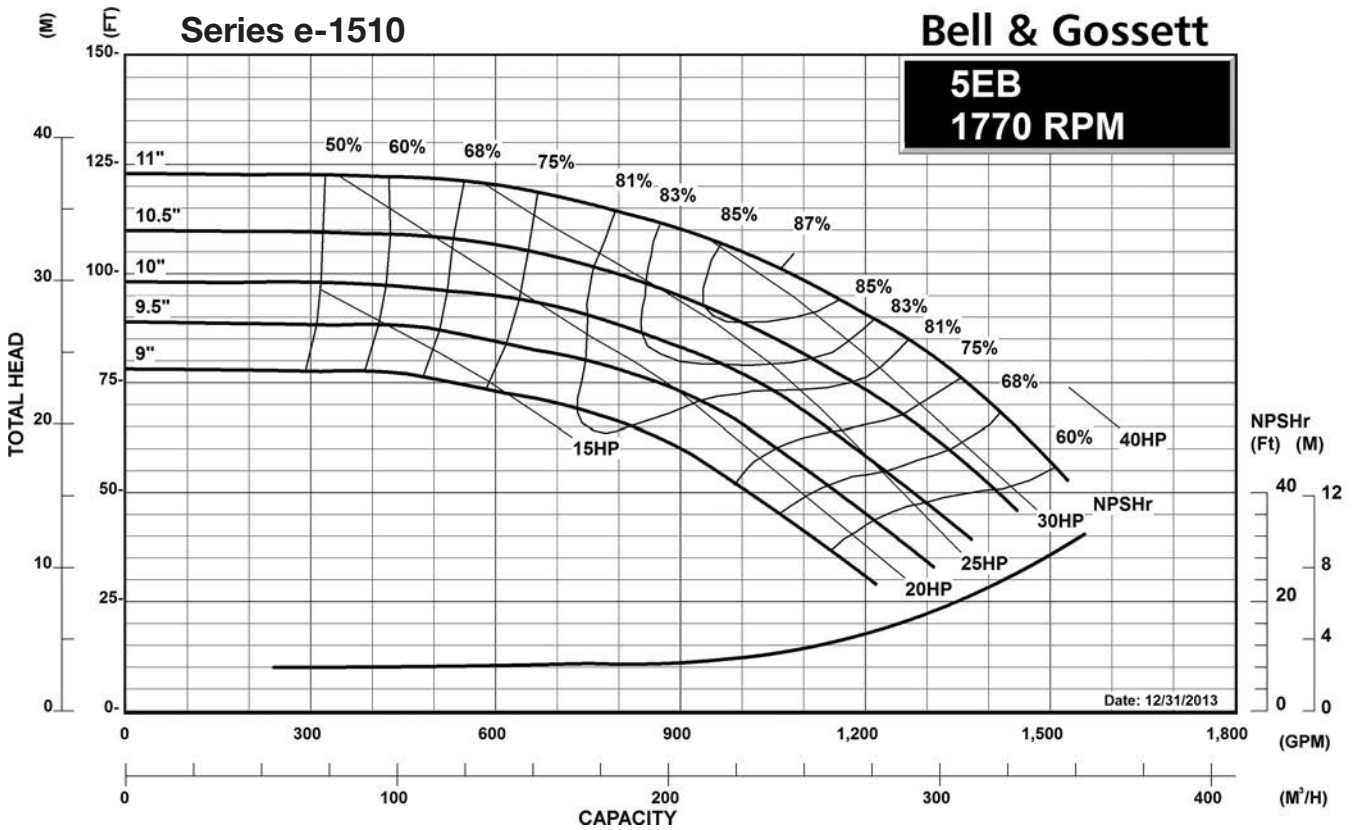
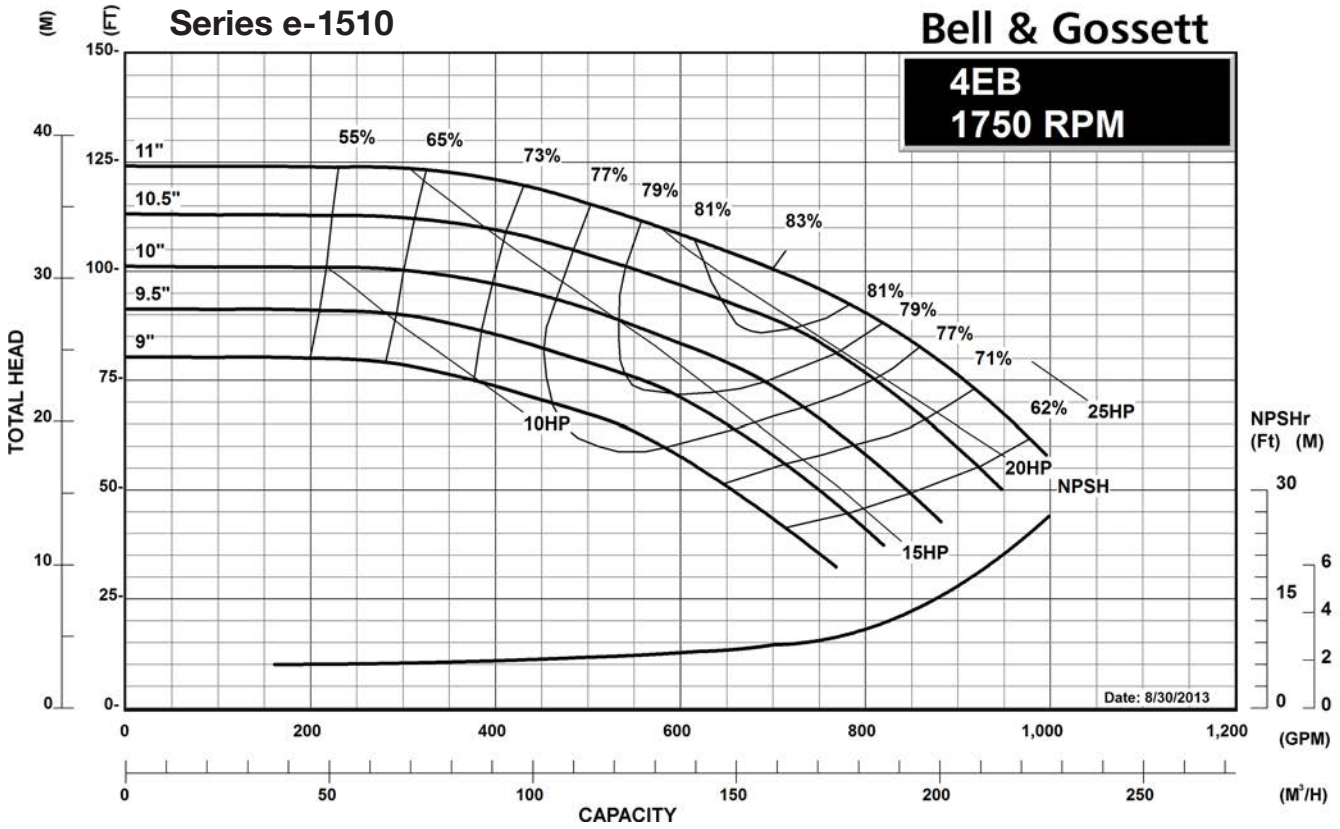

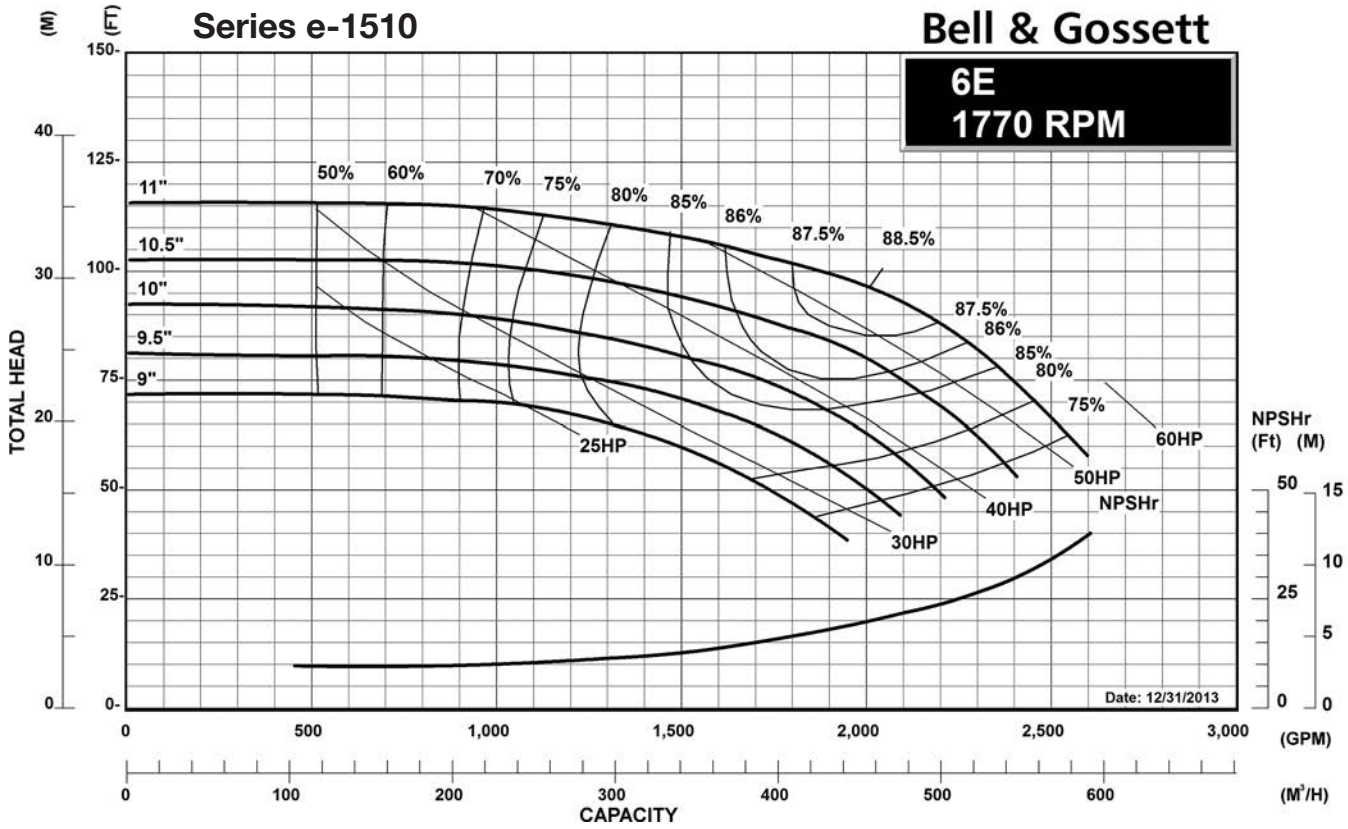

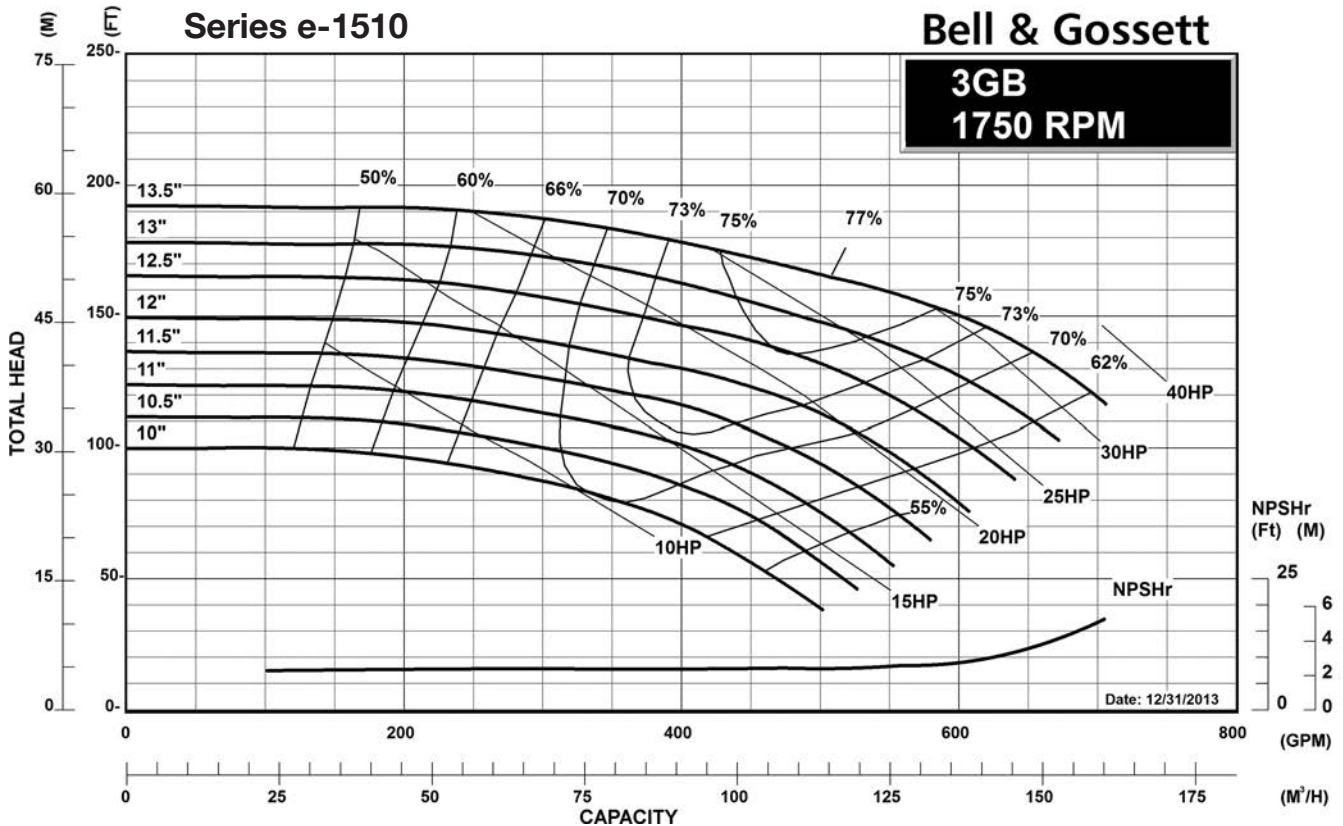
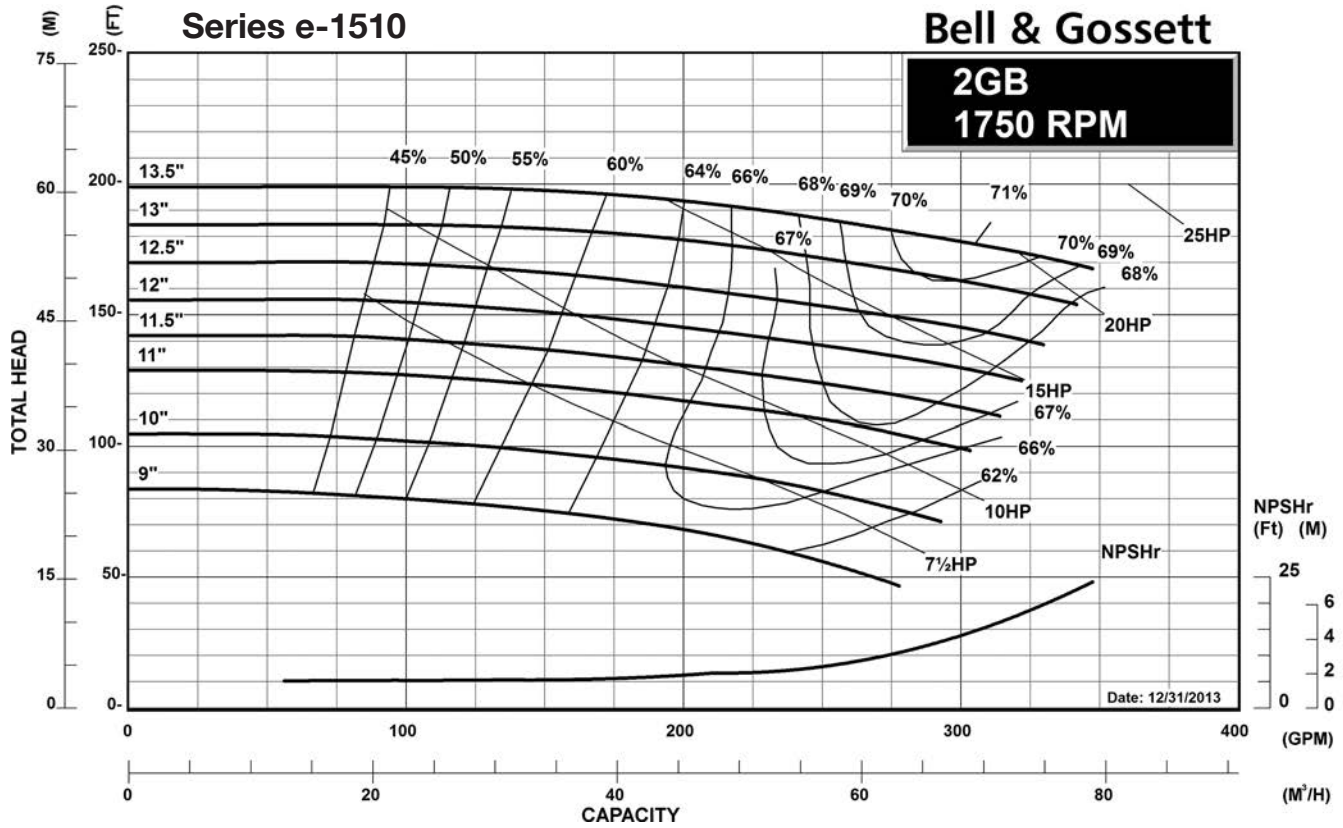

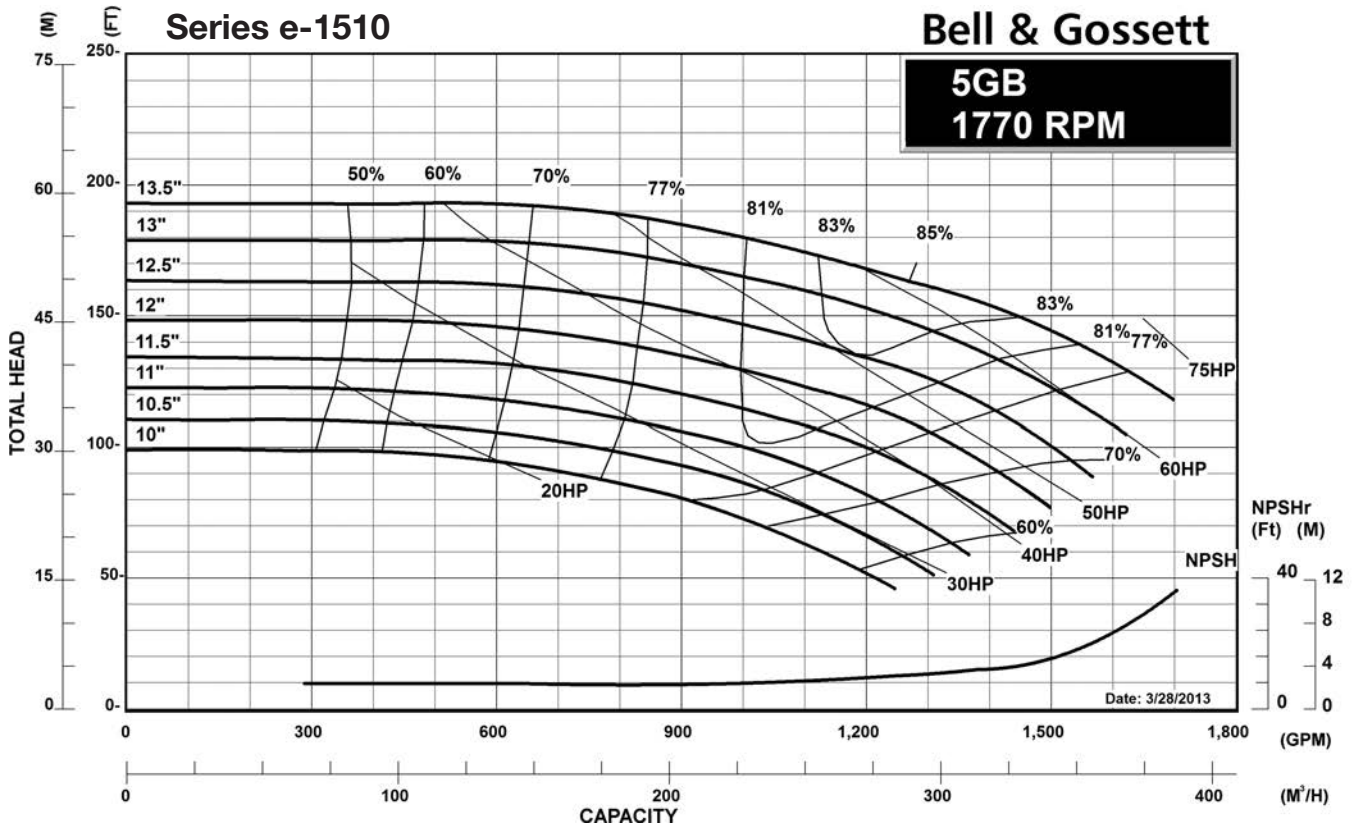
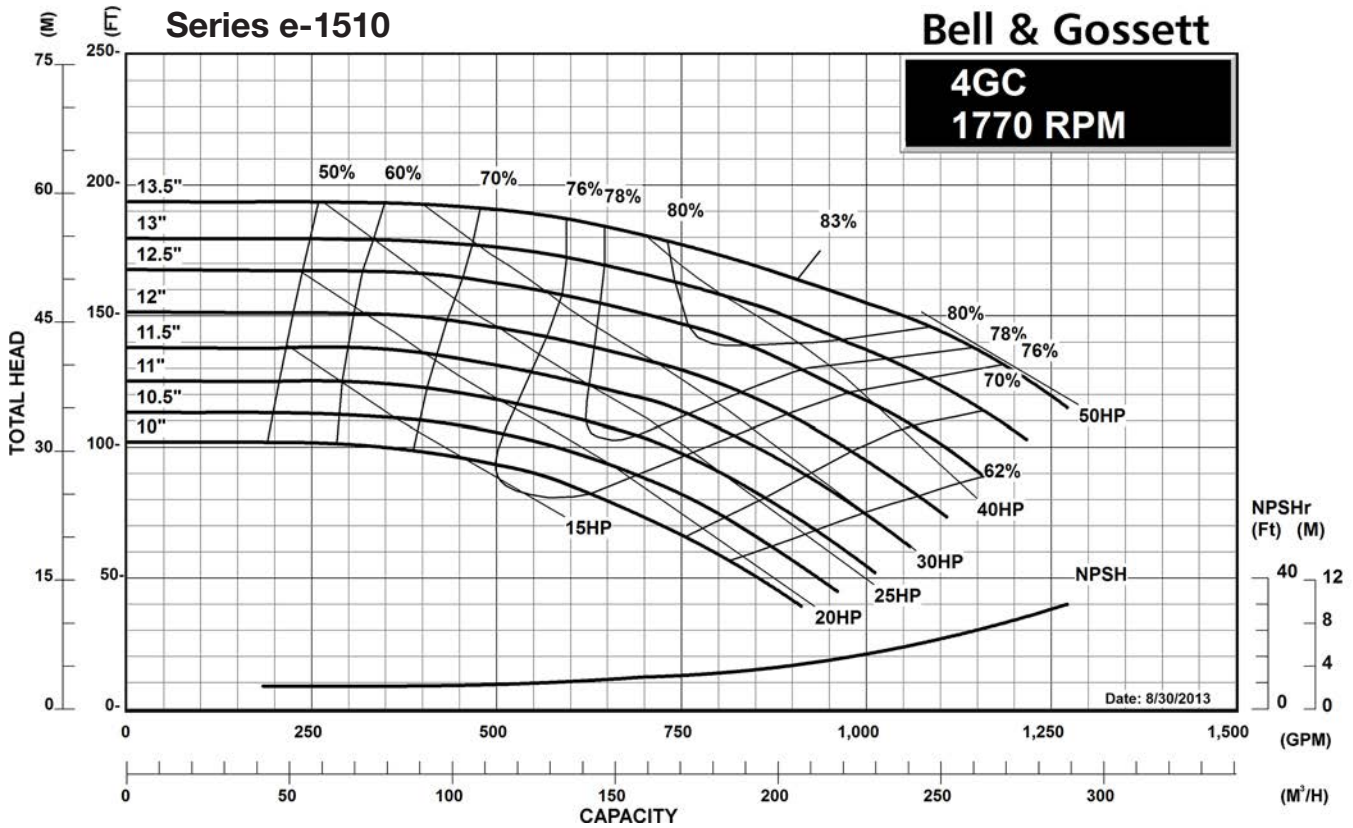

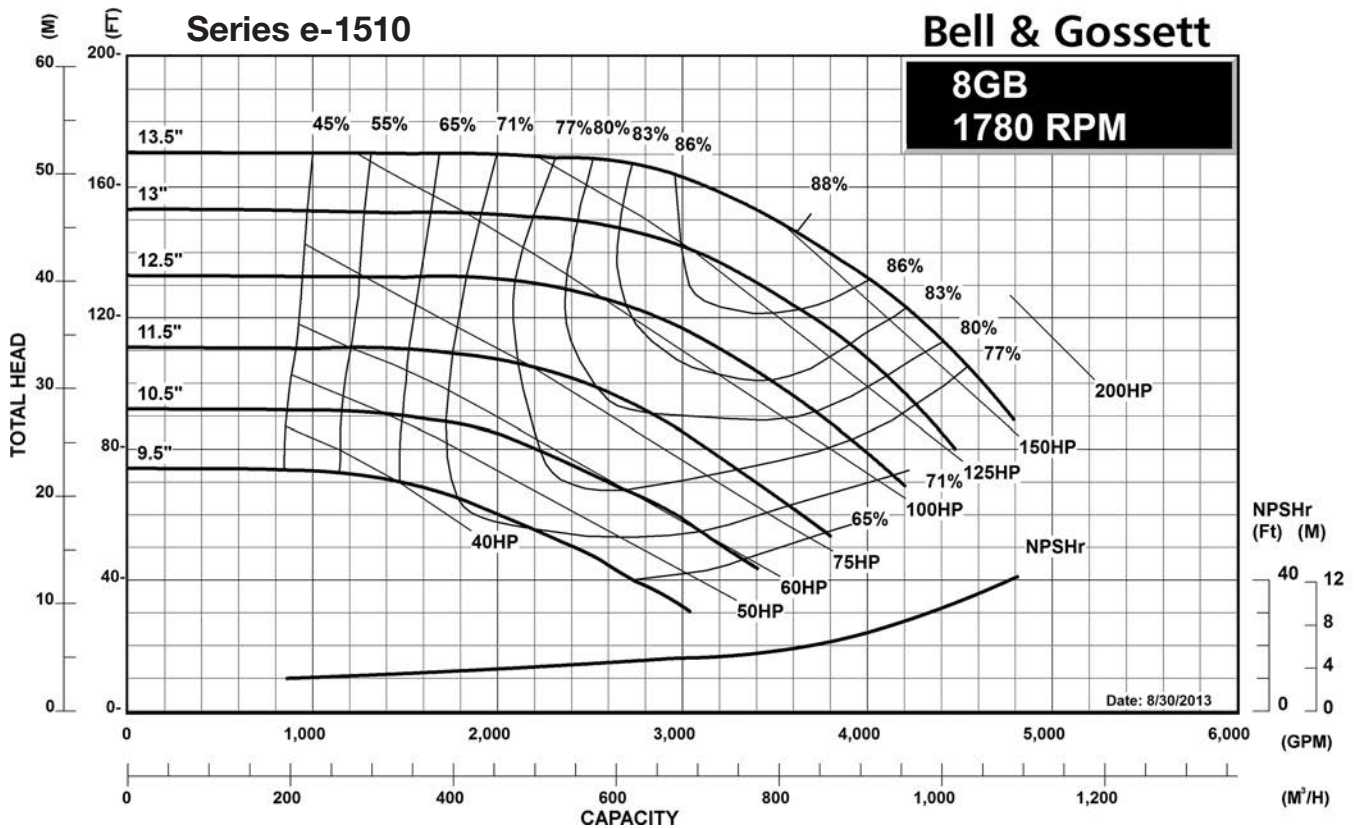
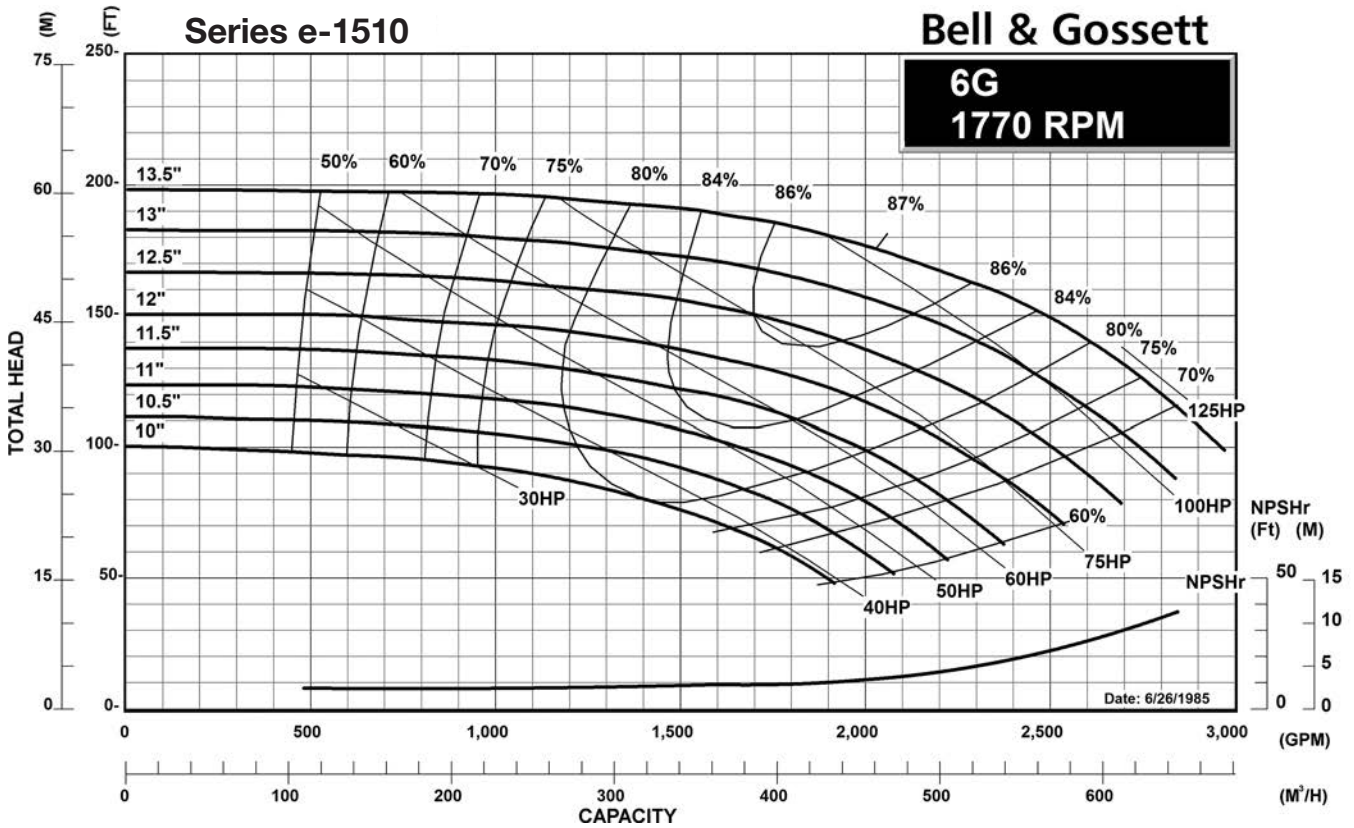

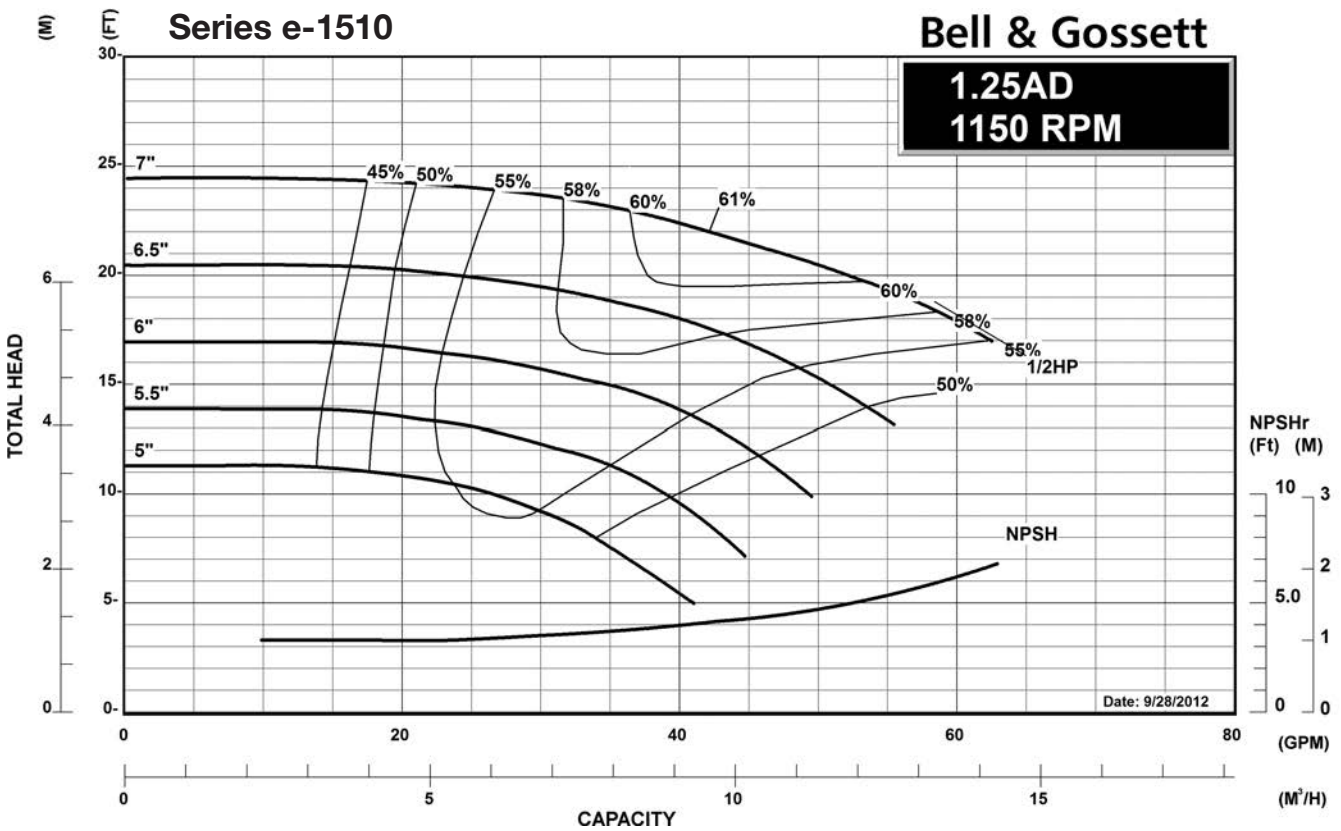
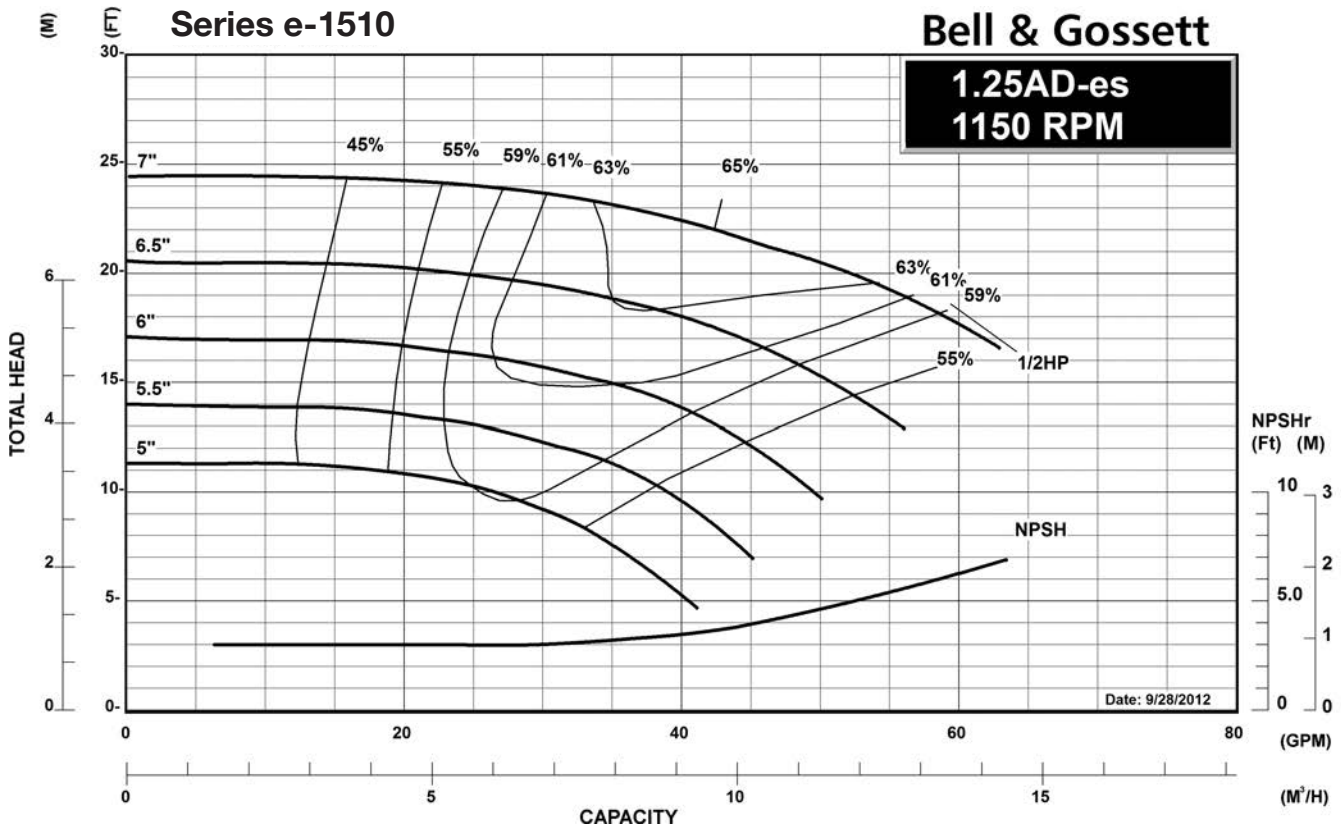

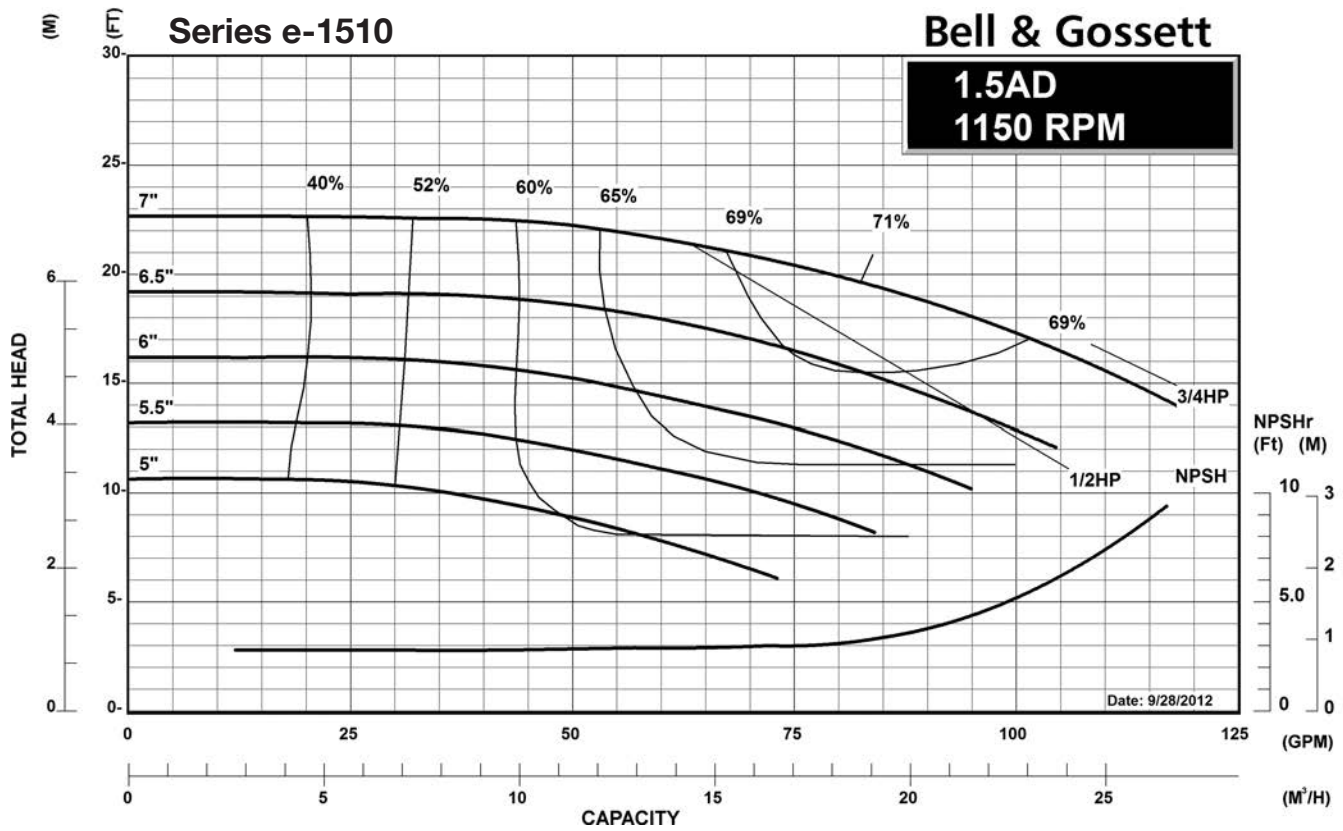
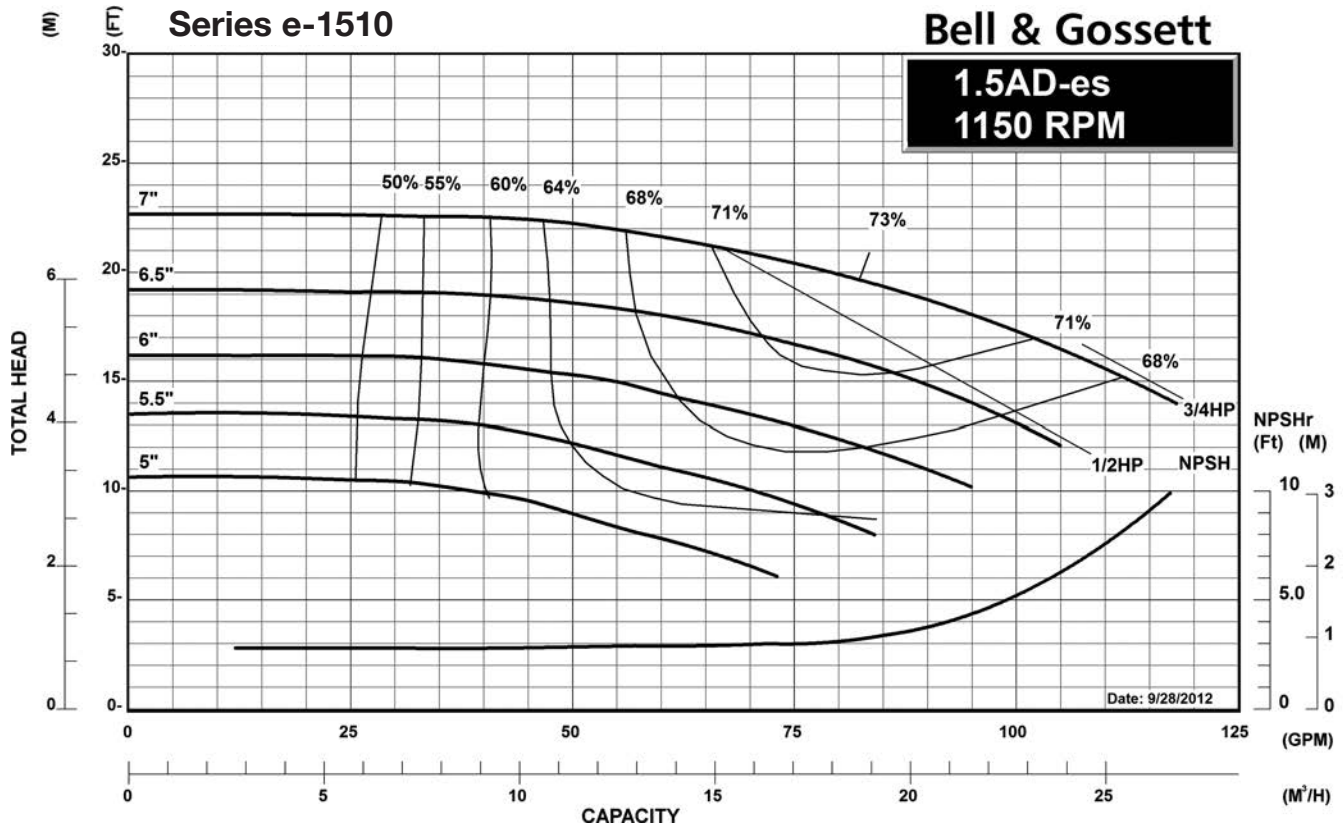

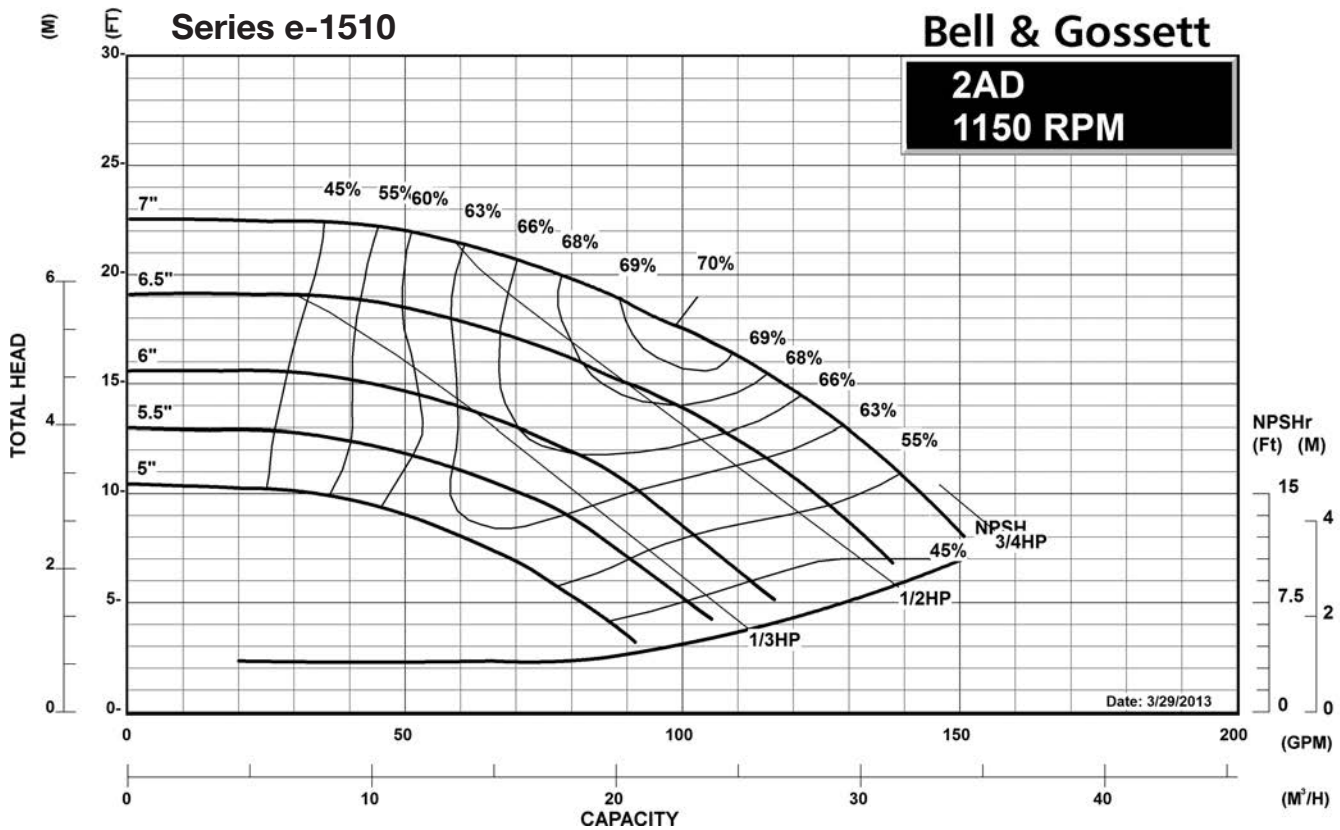
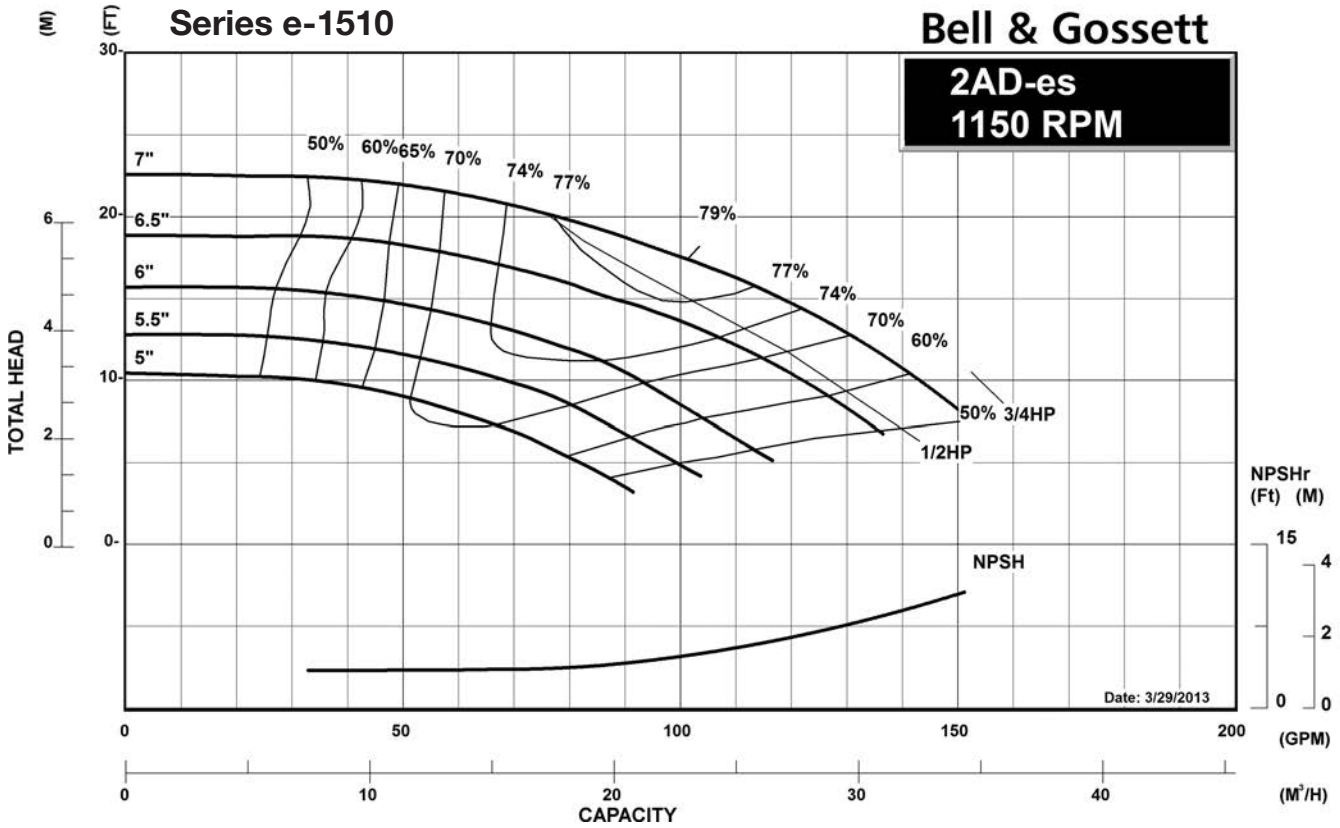

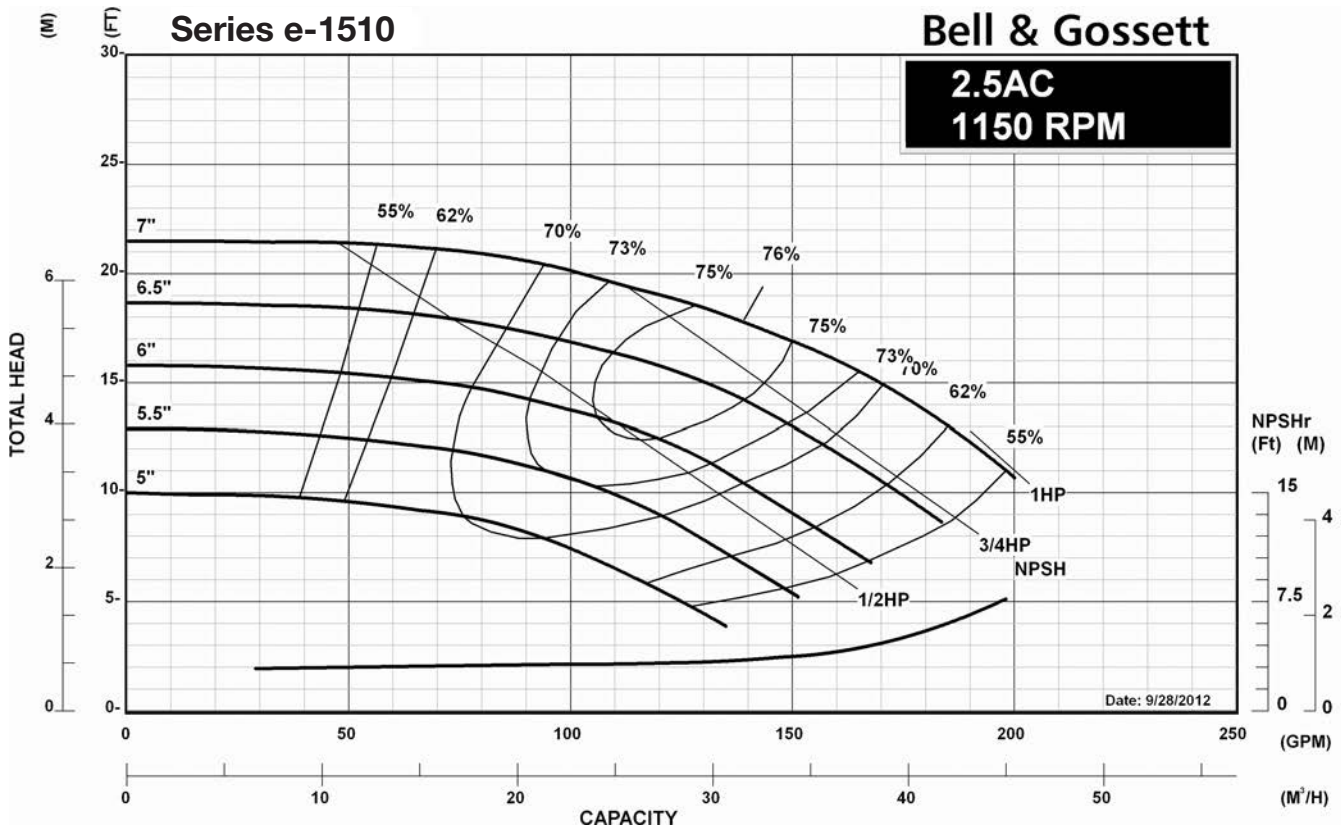
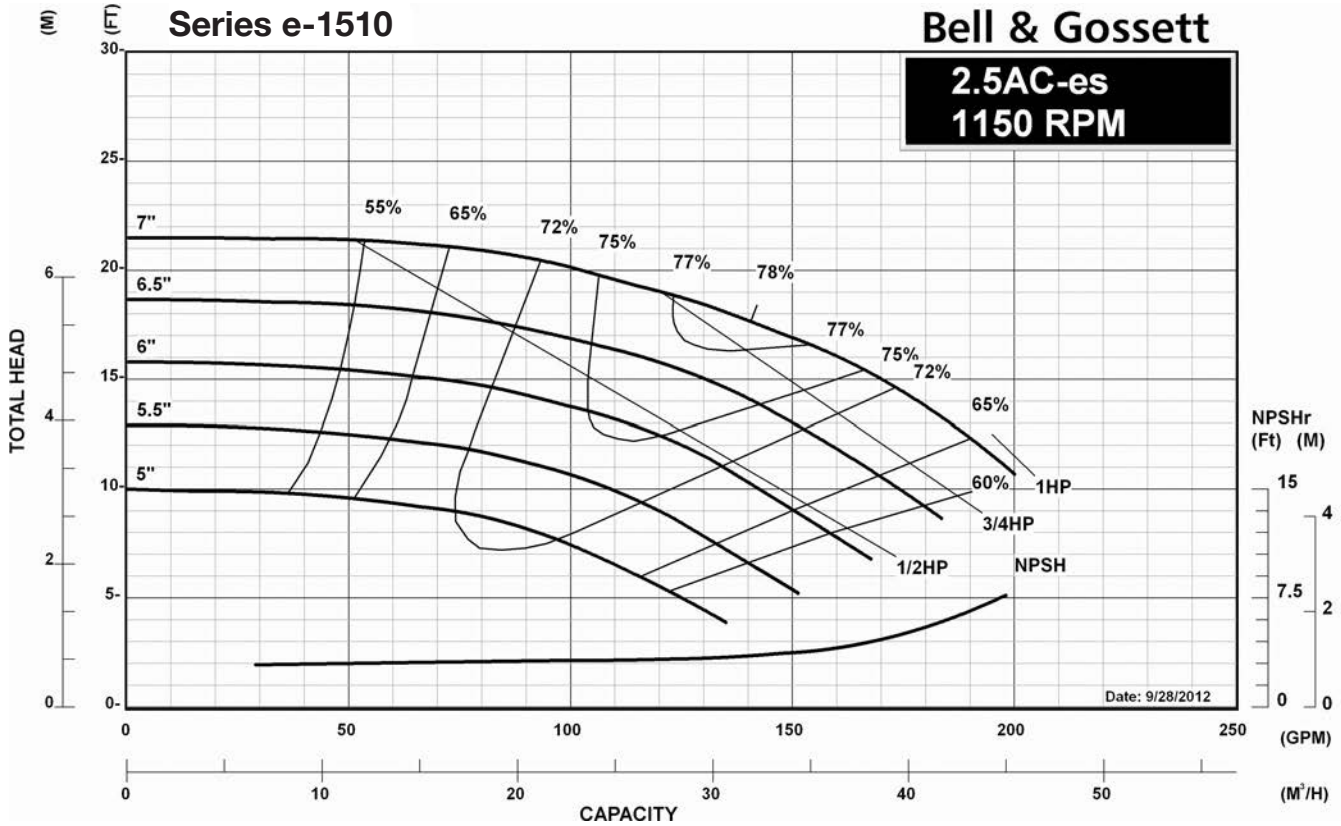

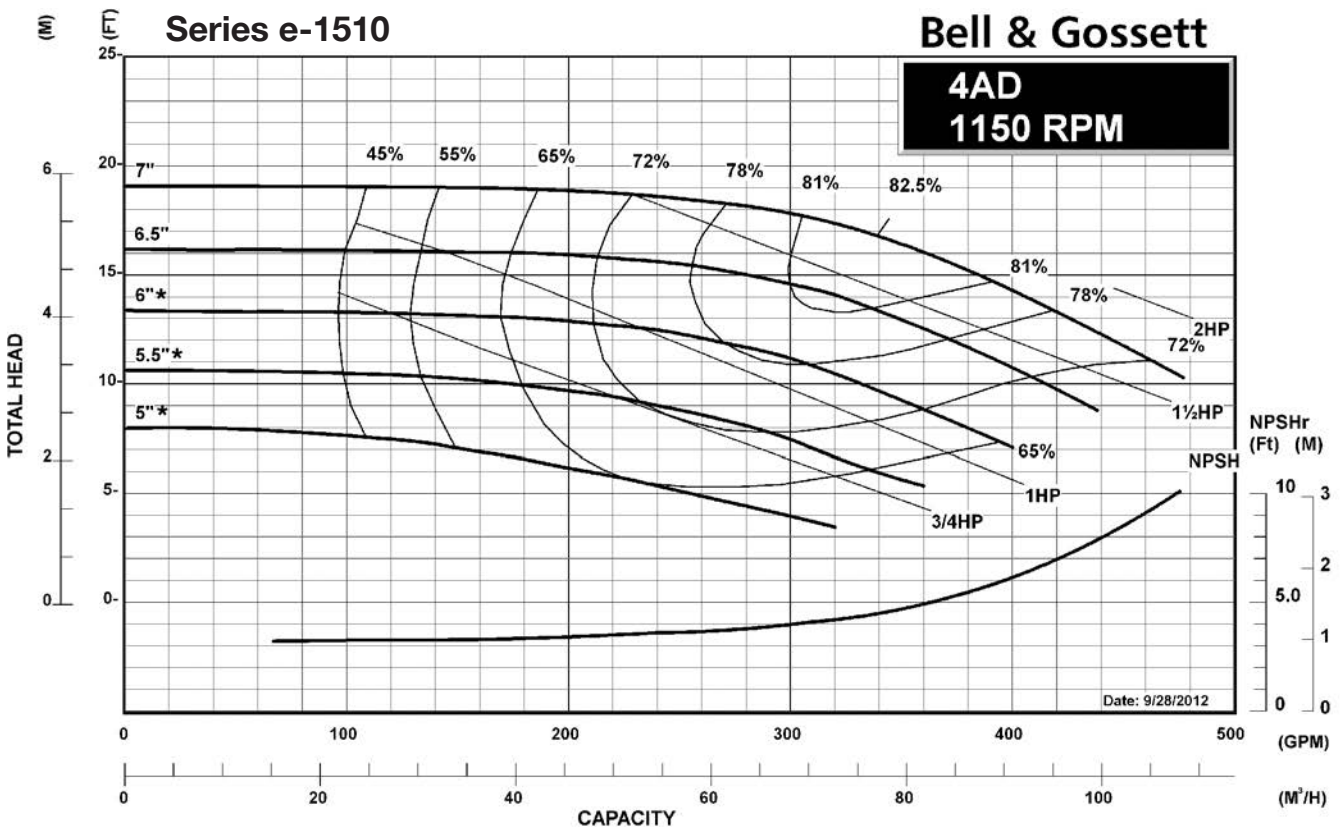
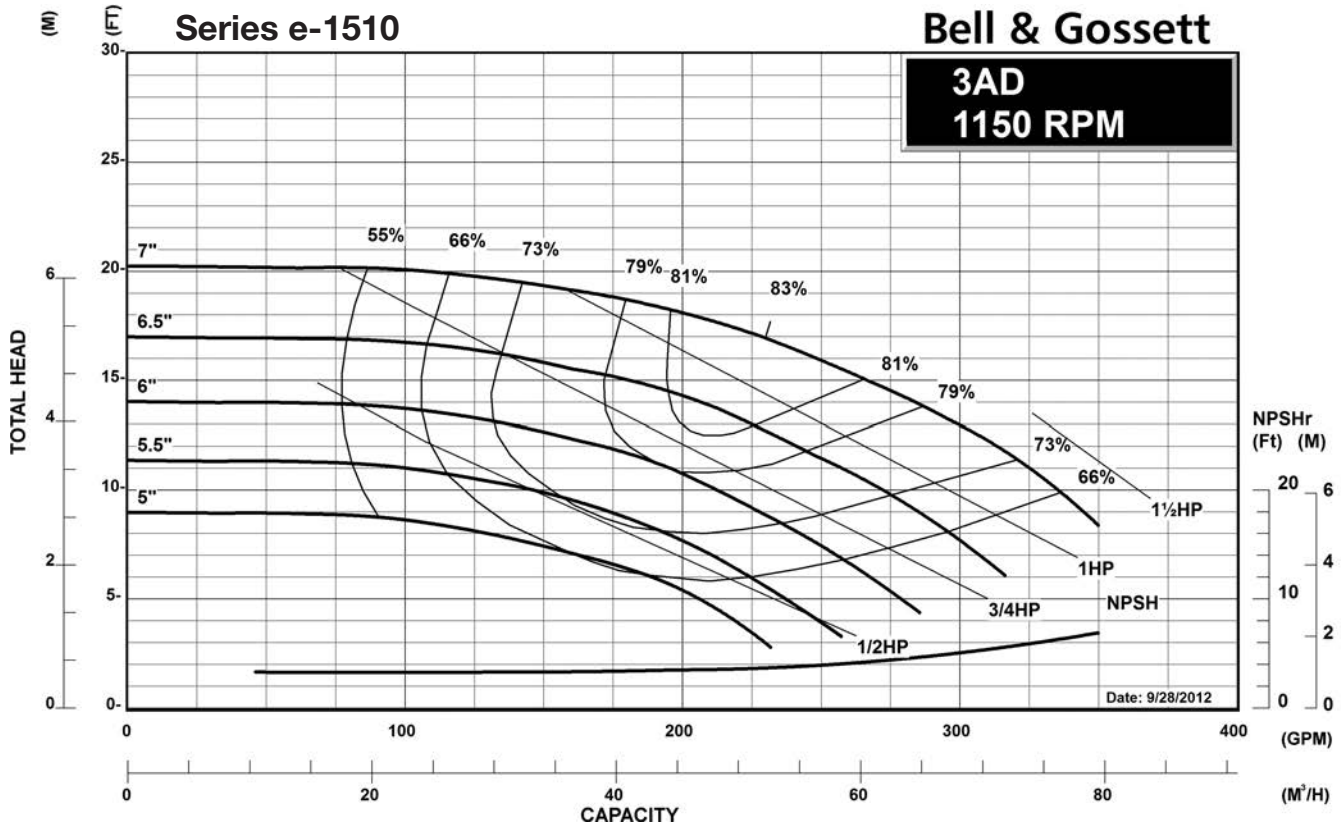

* 6" and below requires oversized diameter and angle trim. See manual.

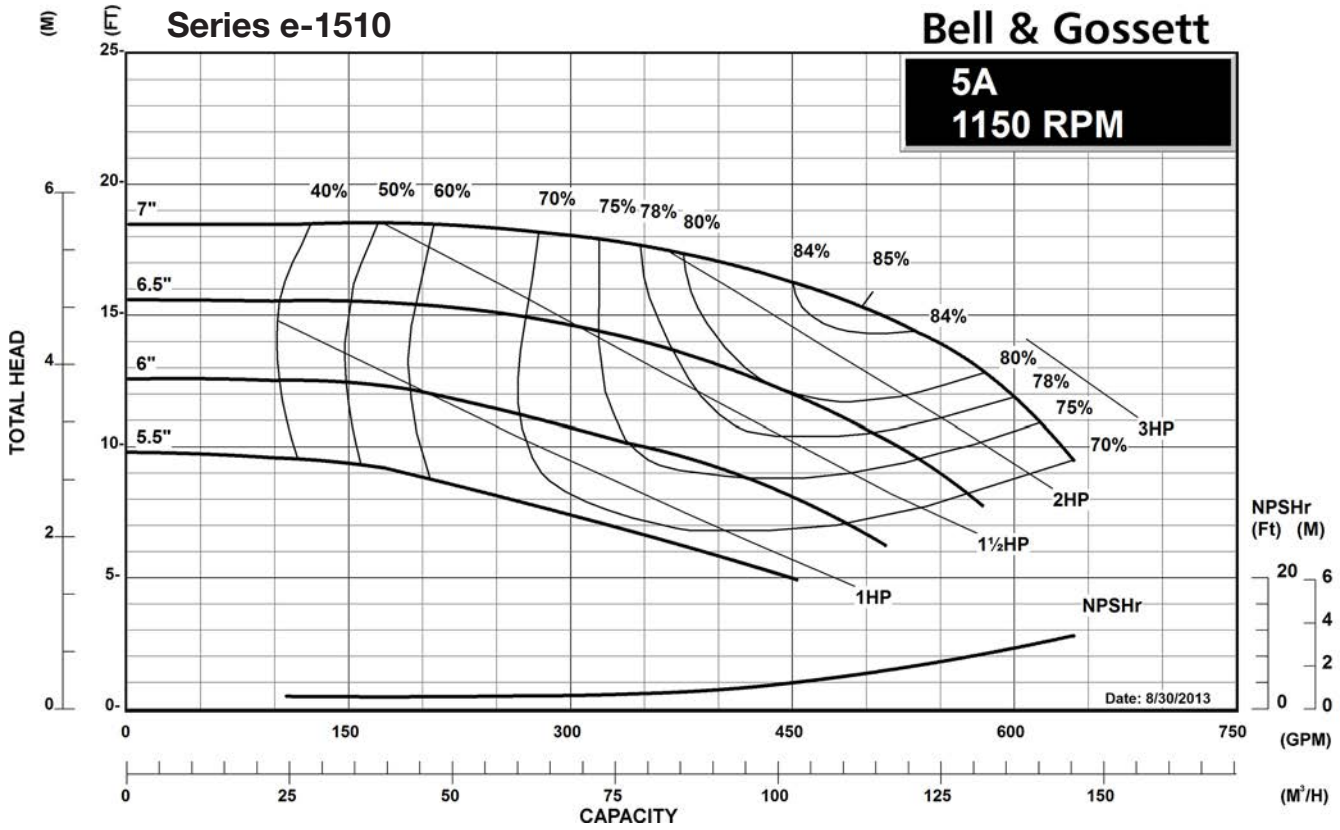

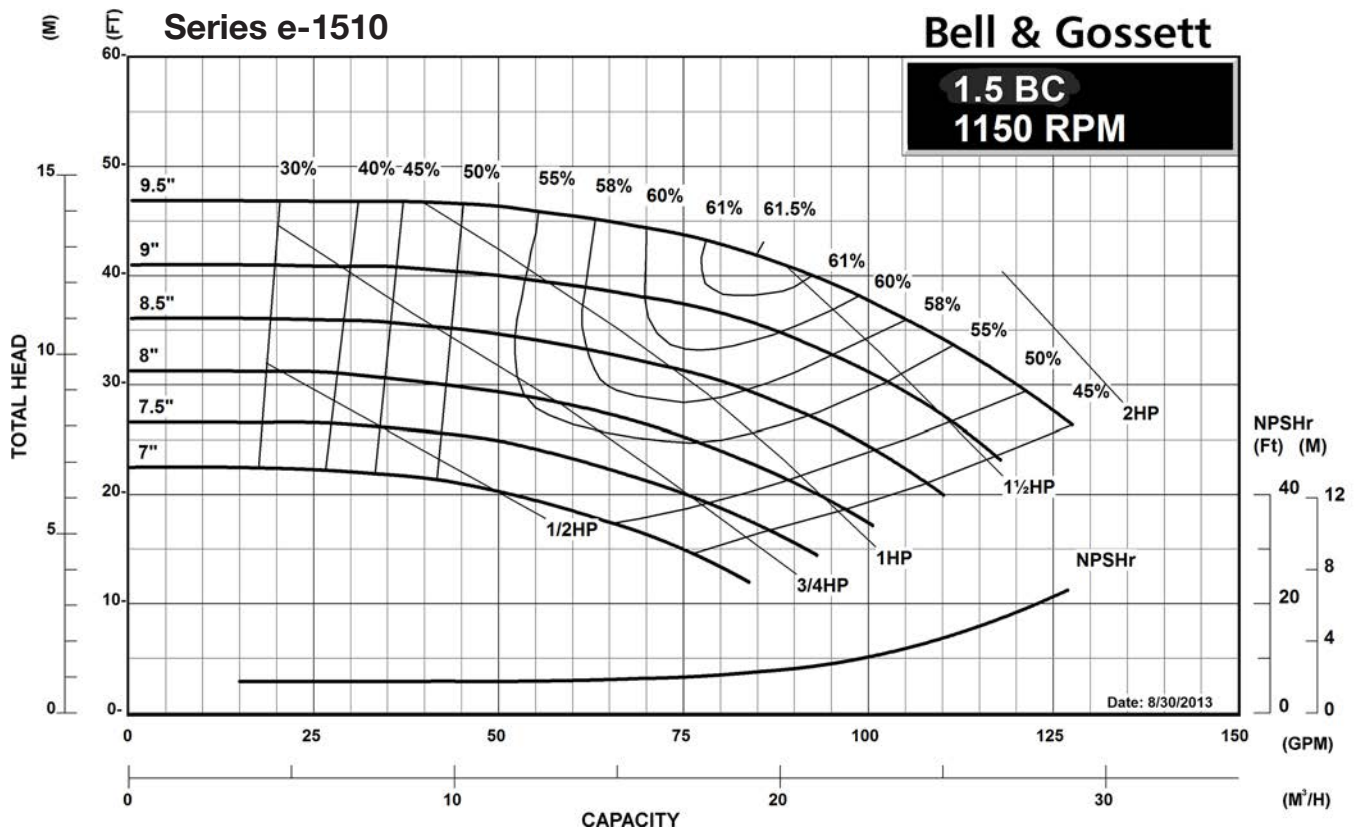
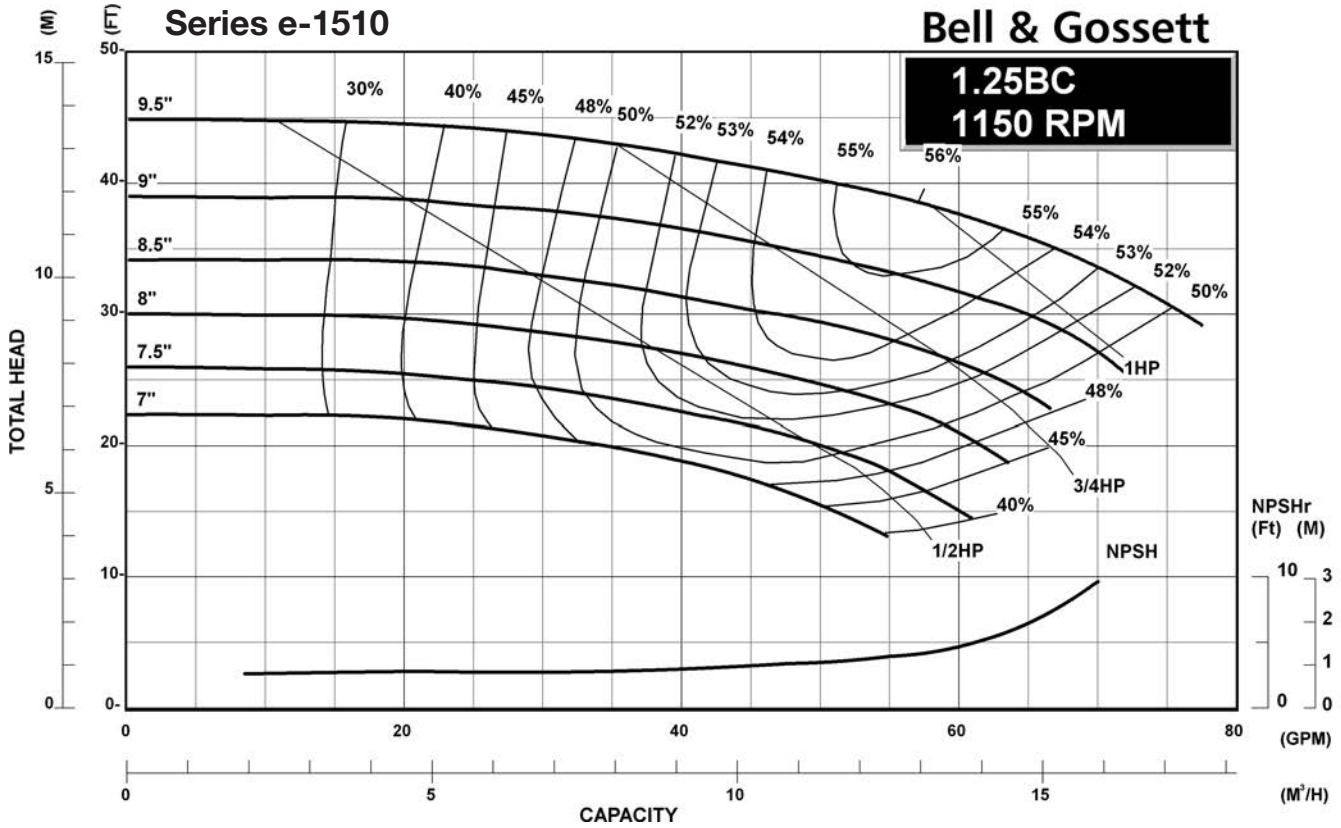

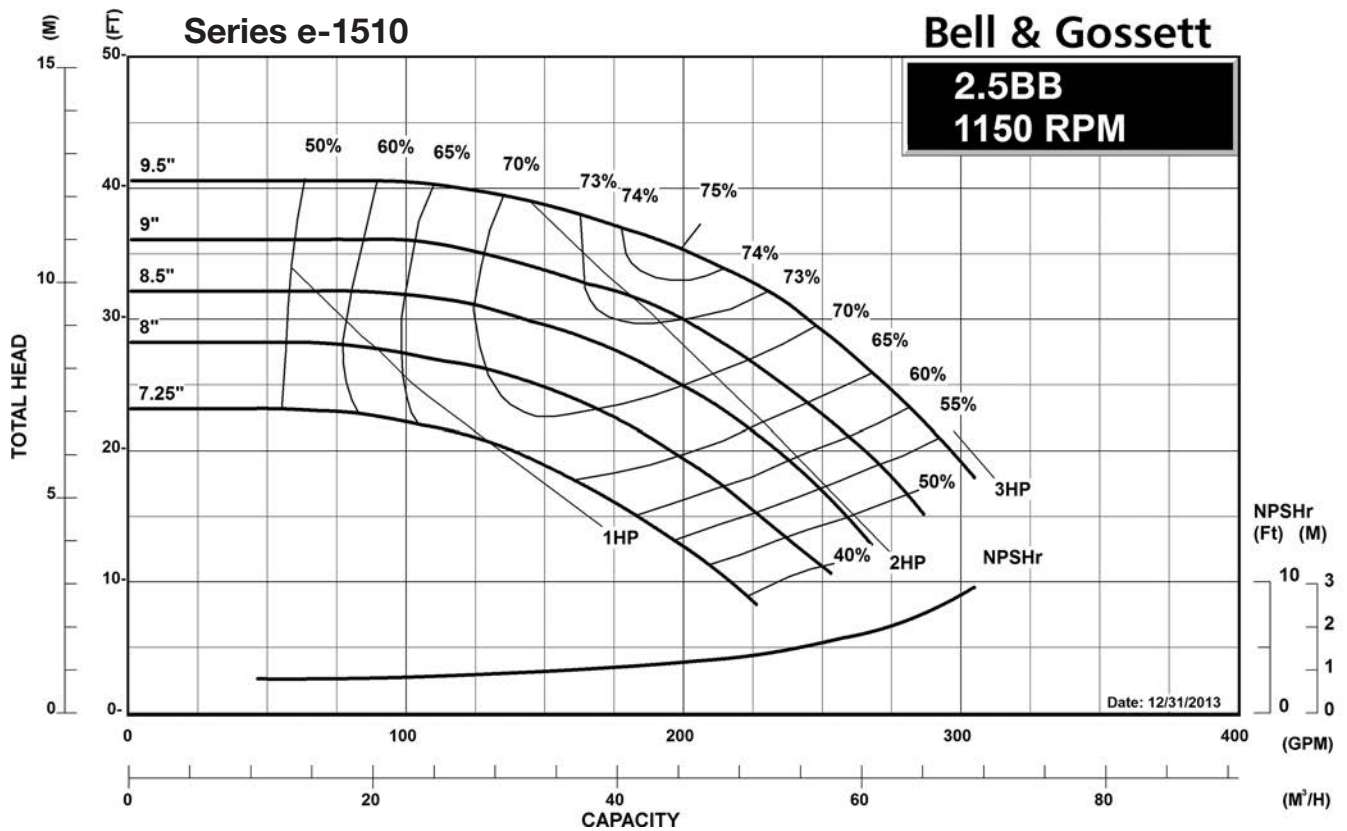
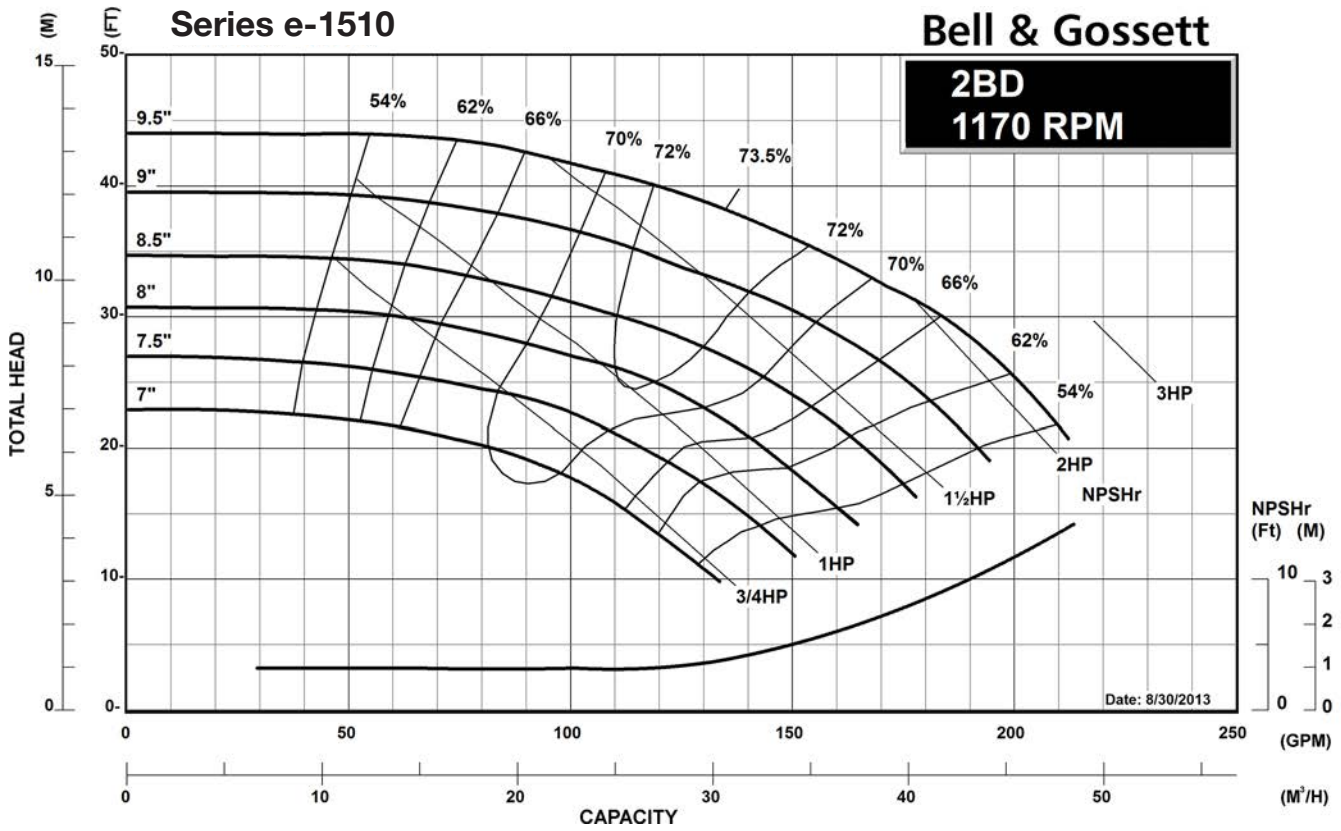

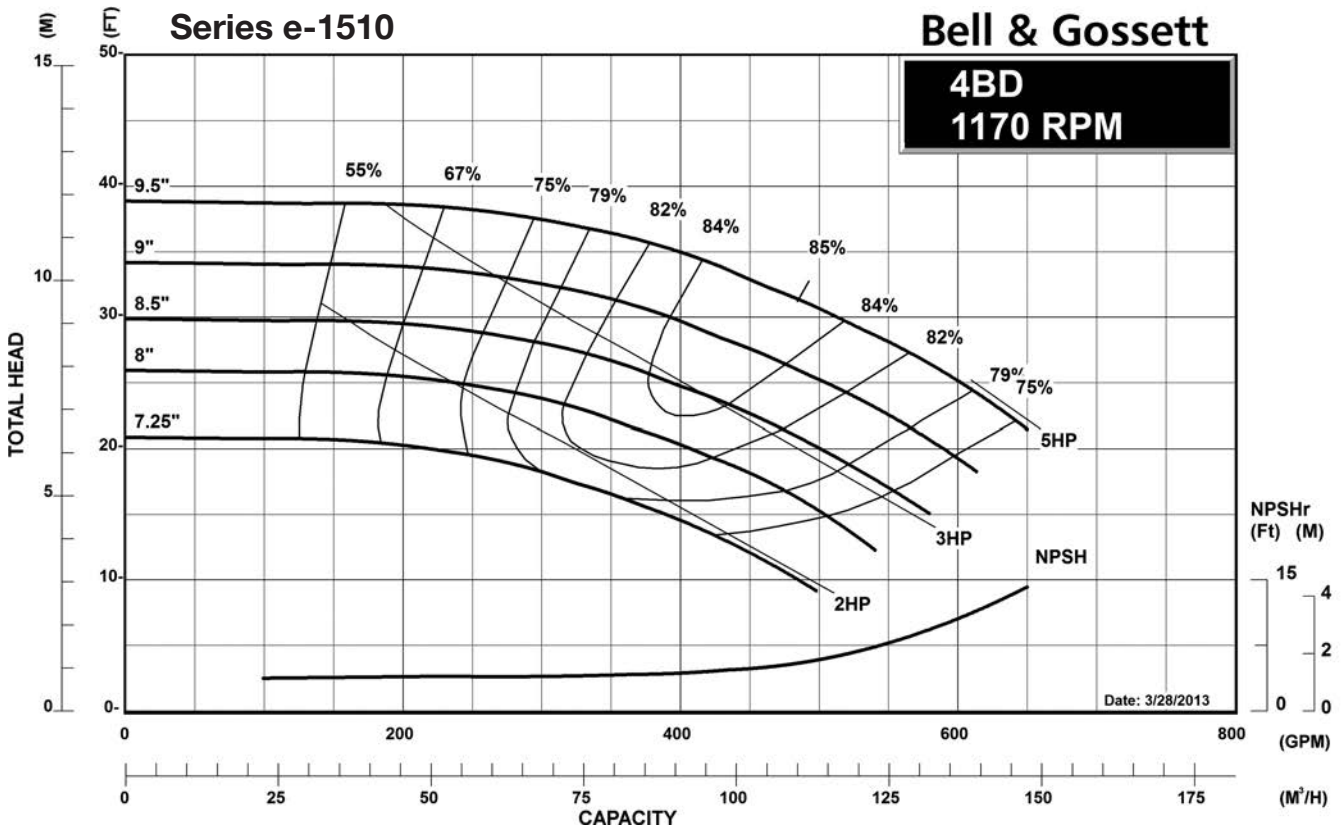
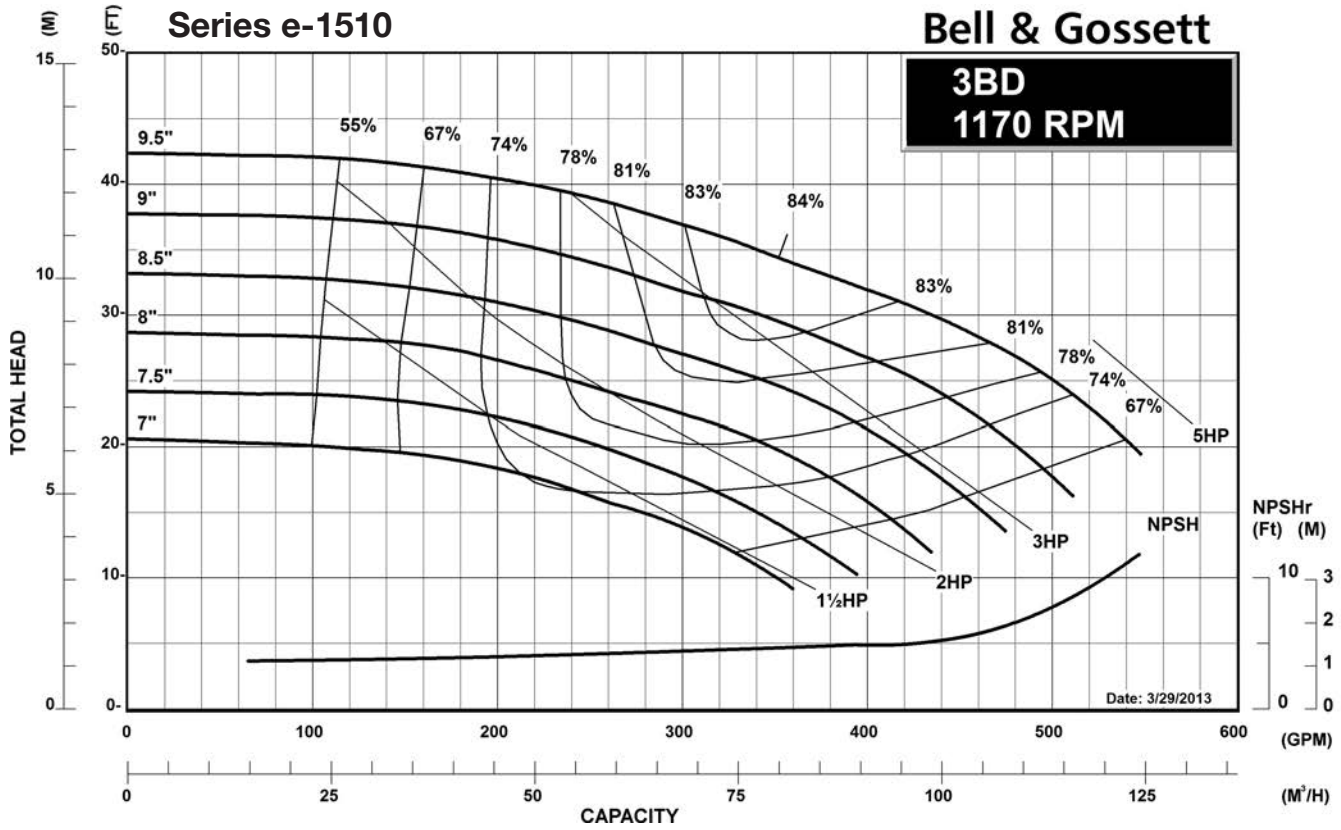

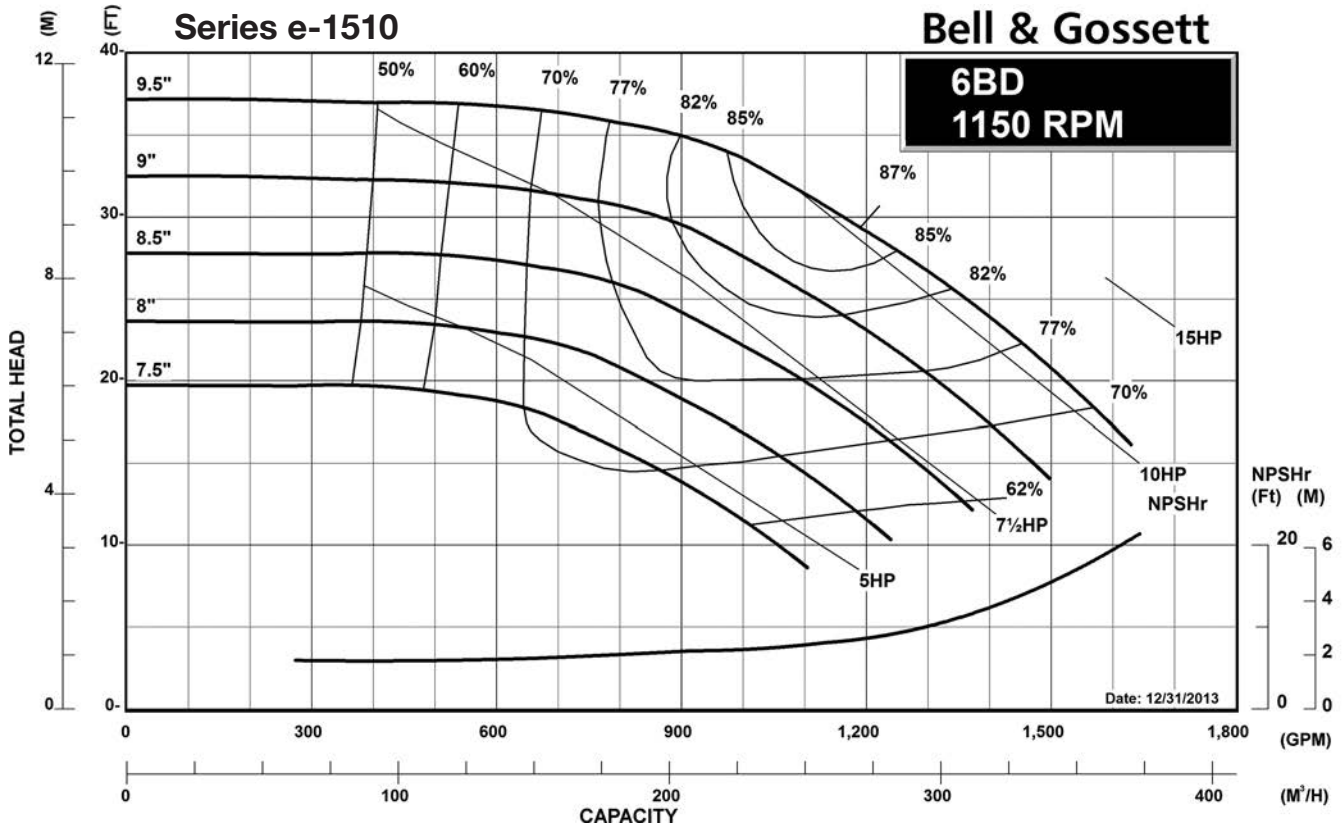
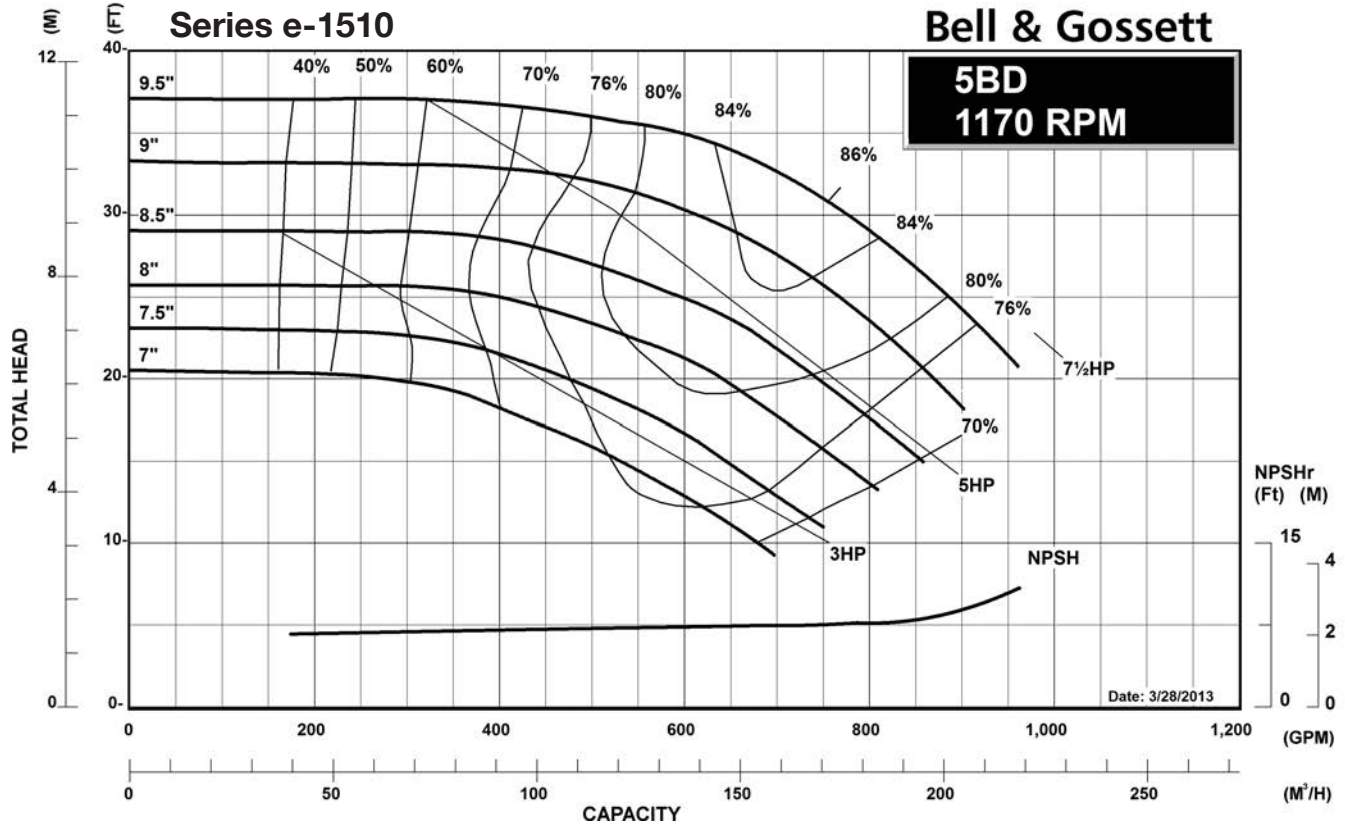

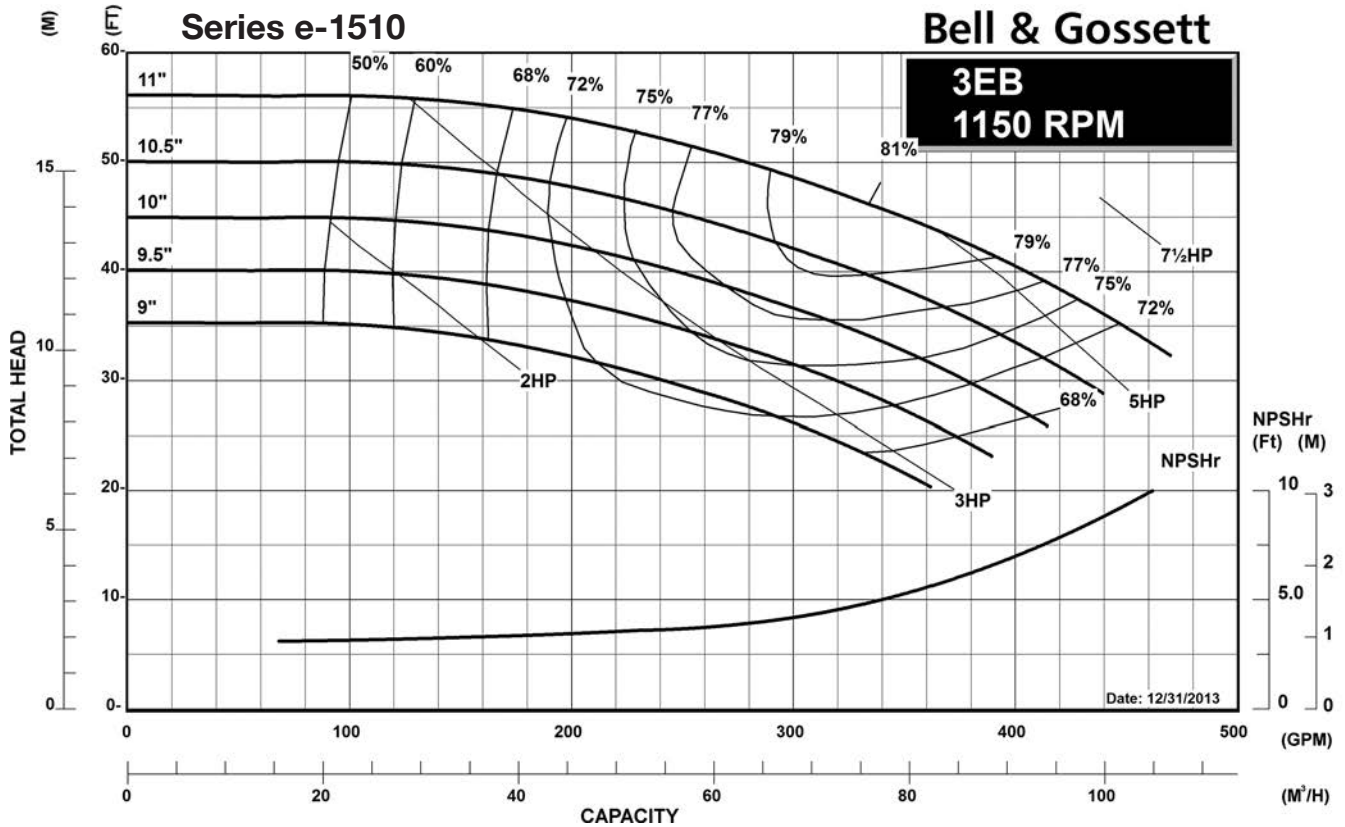
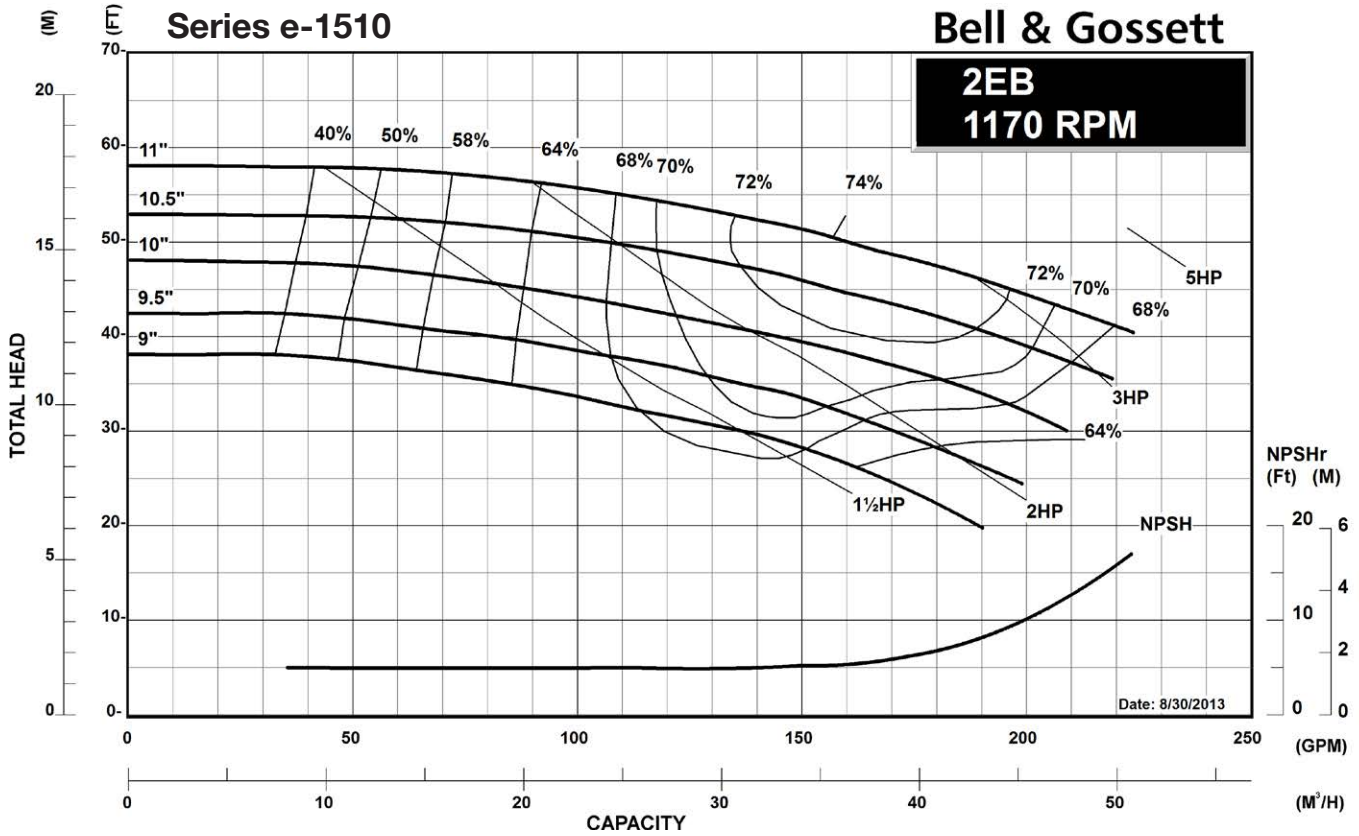

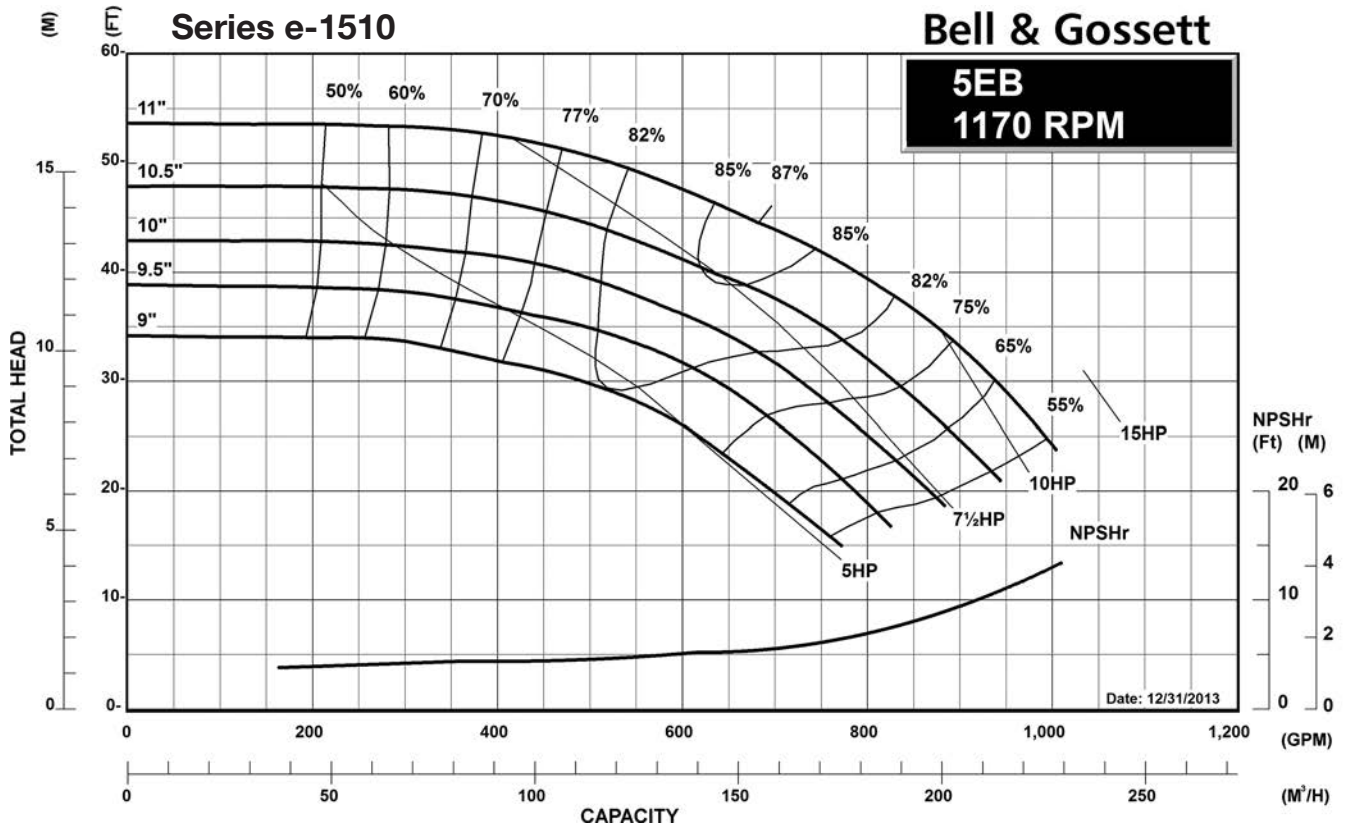
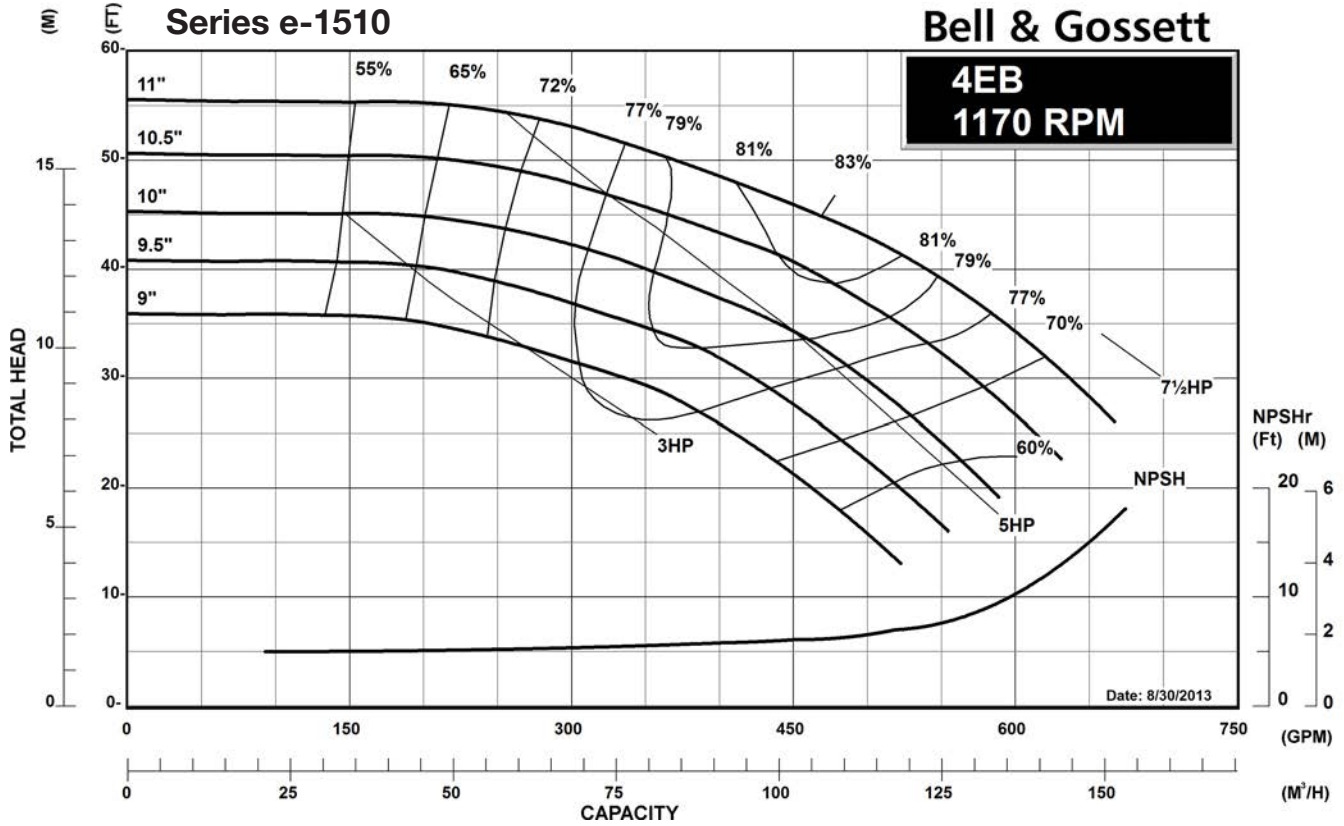

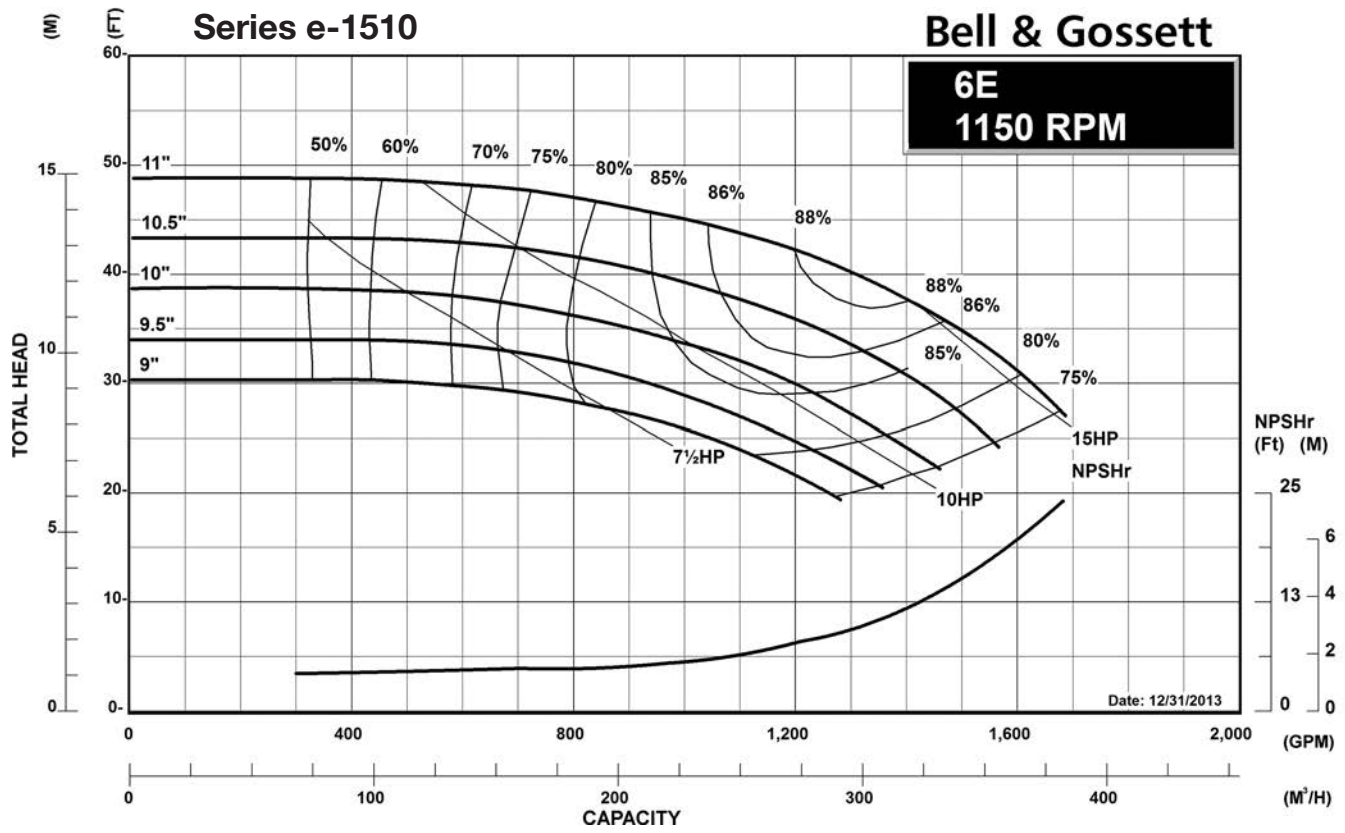

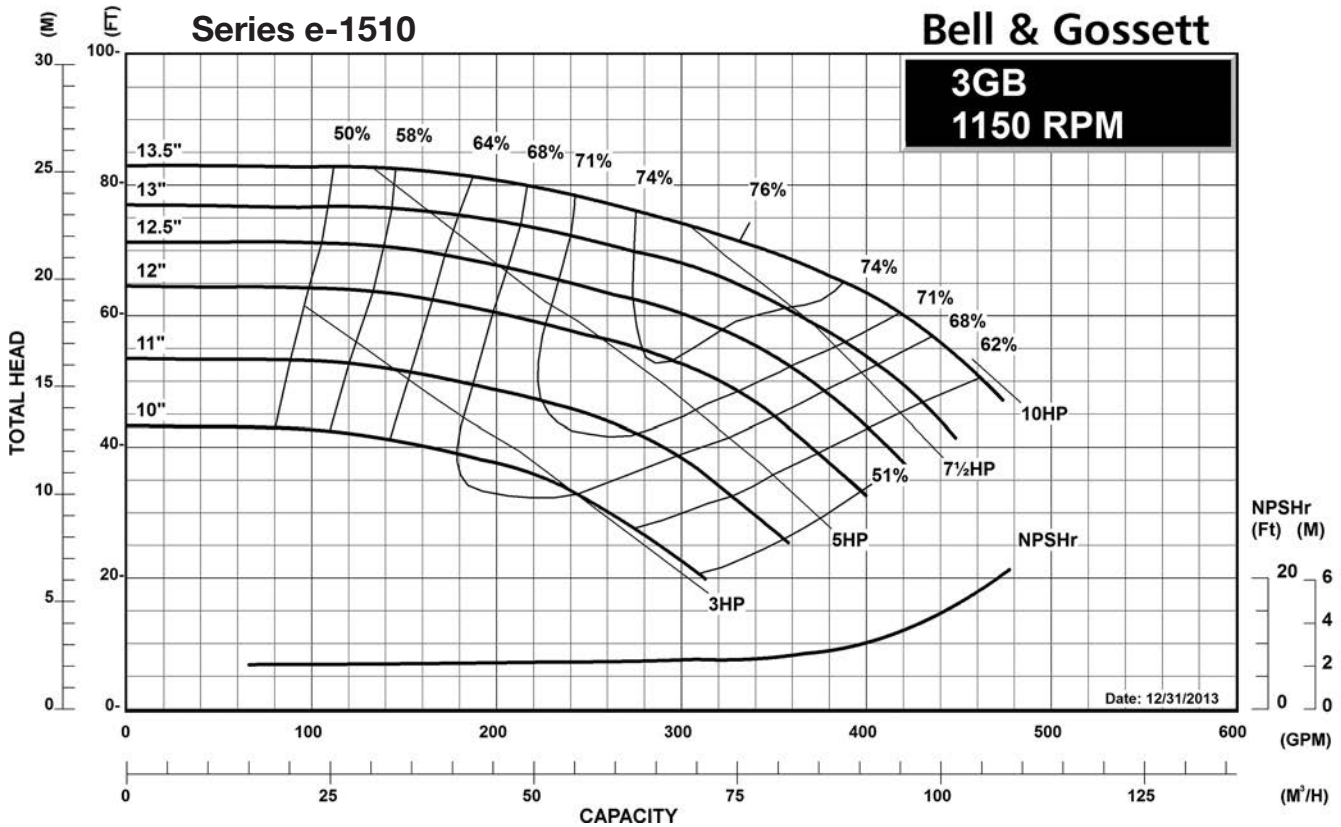
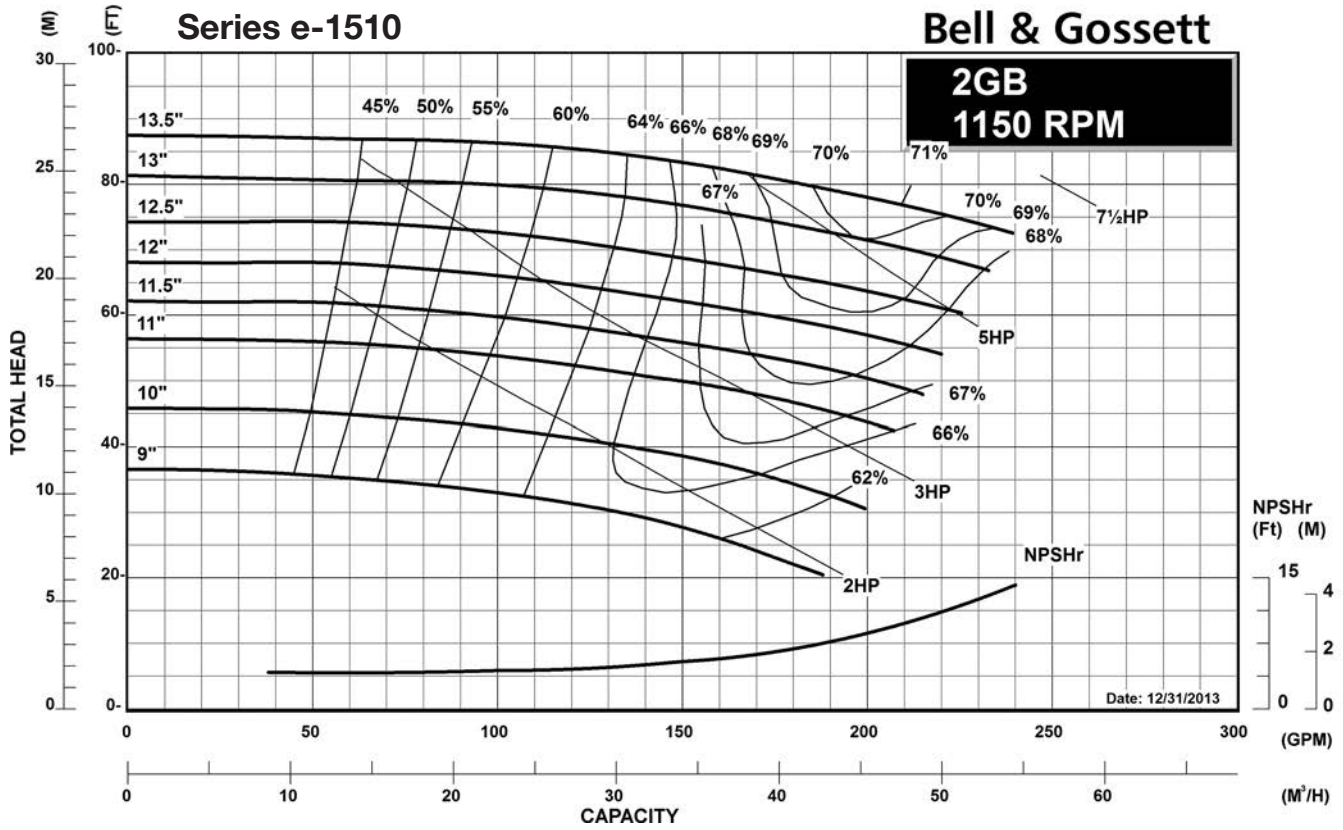

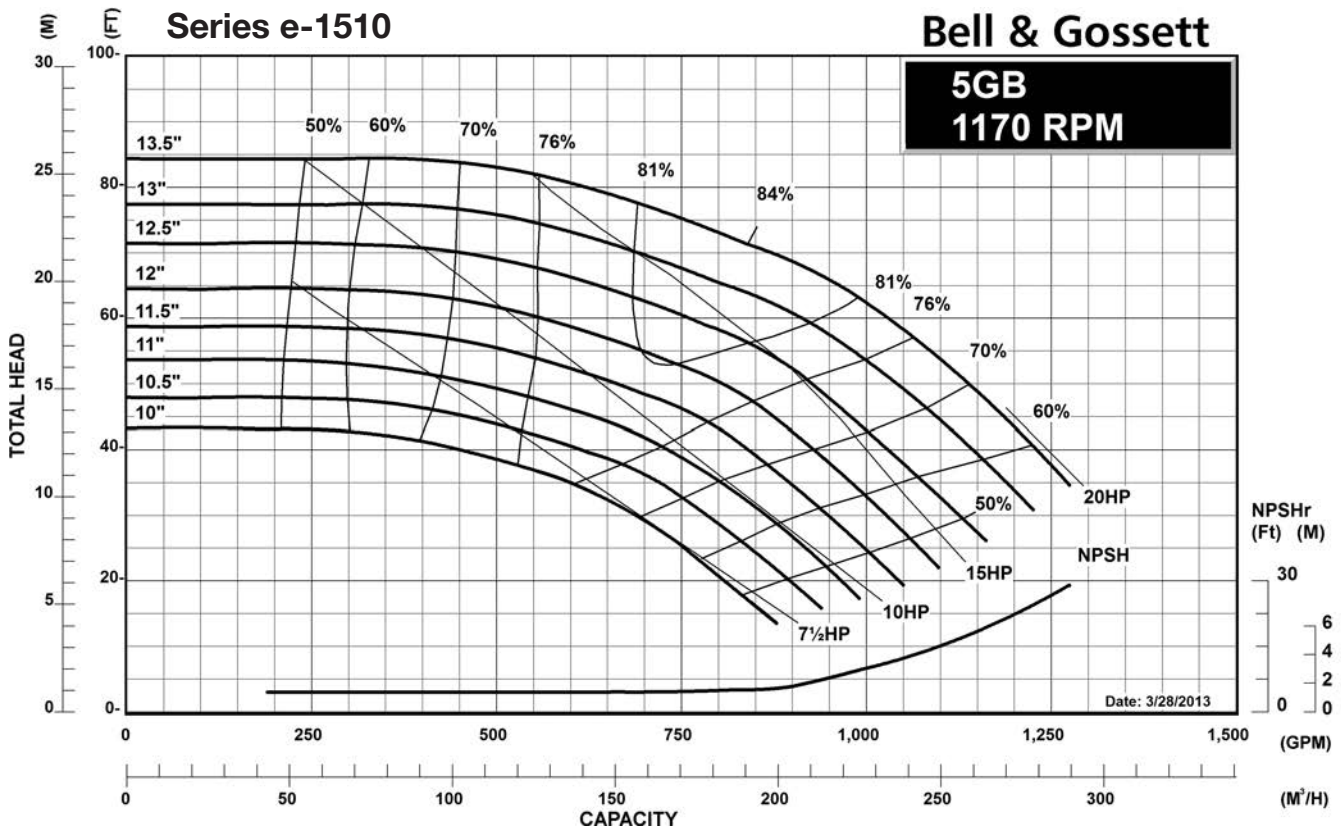
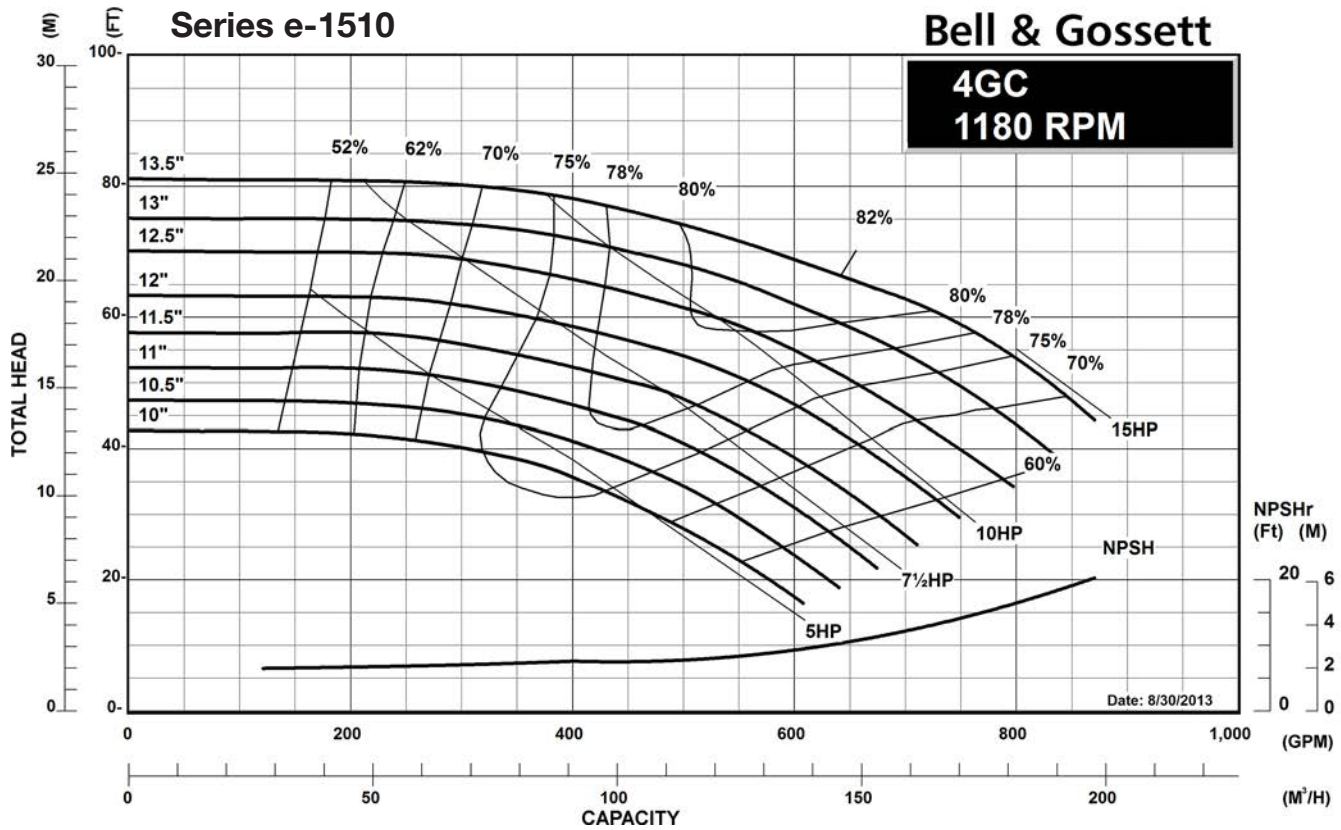

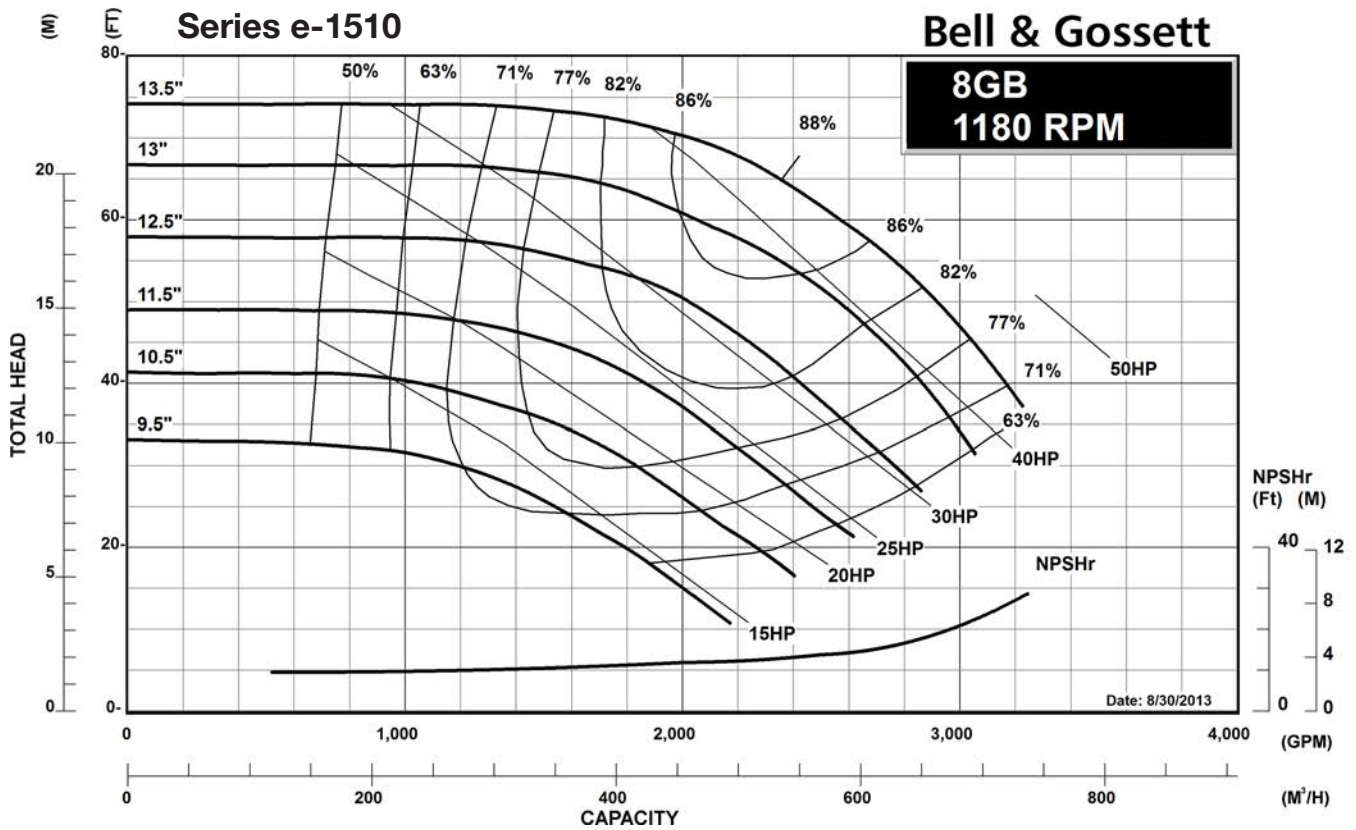
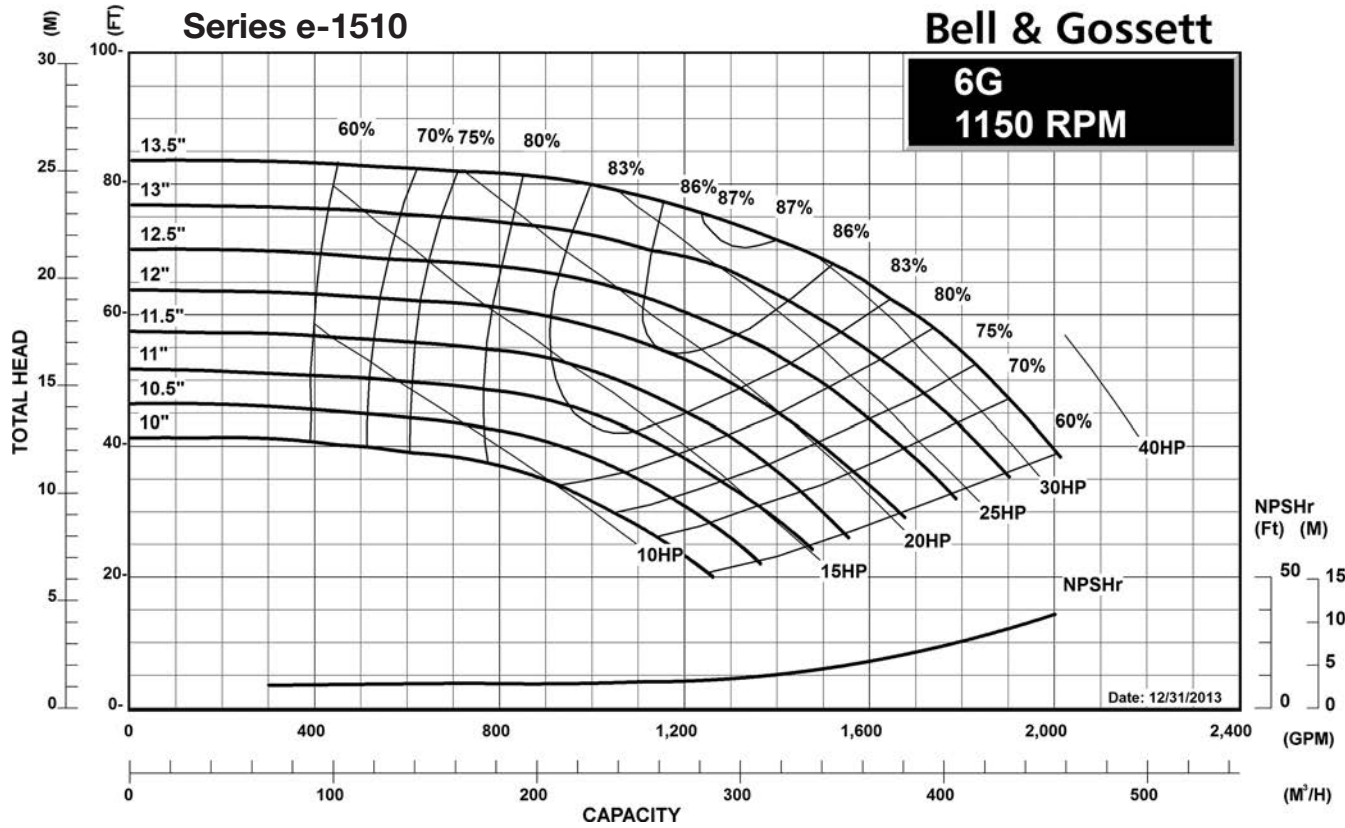

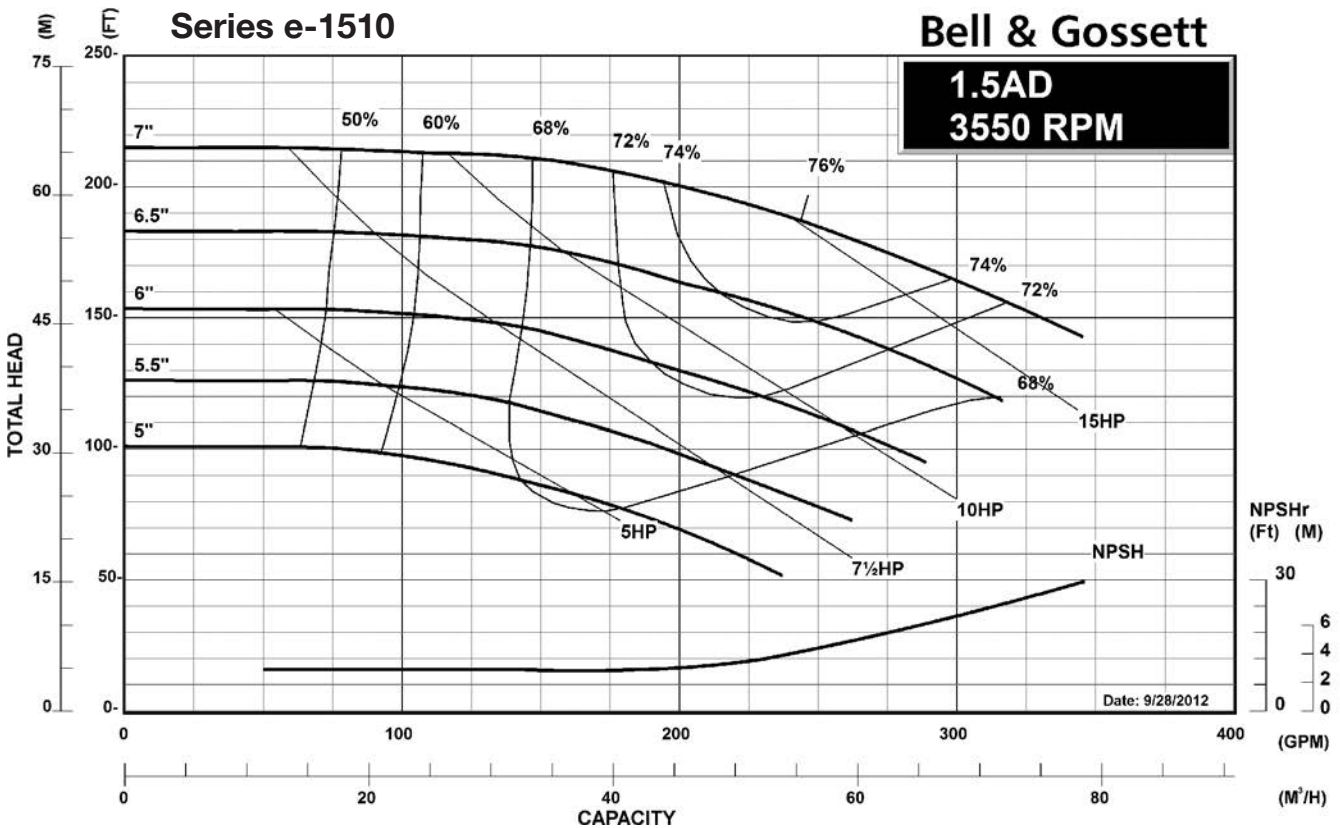
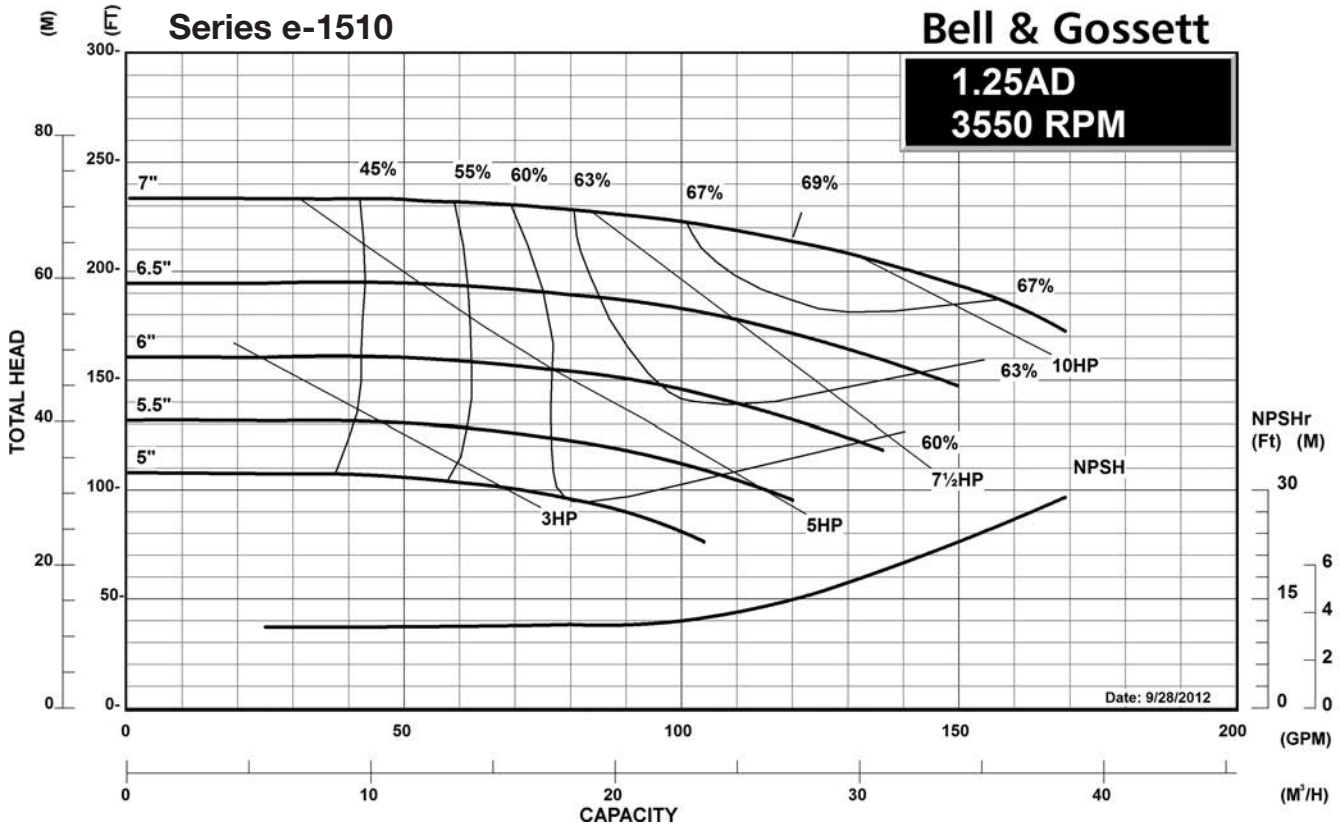

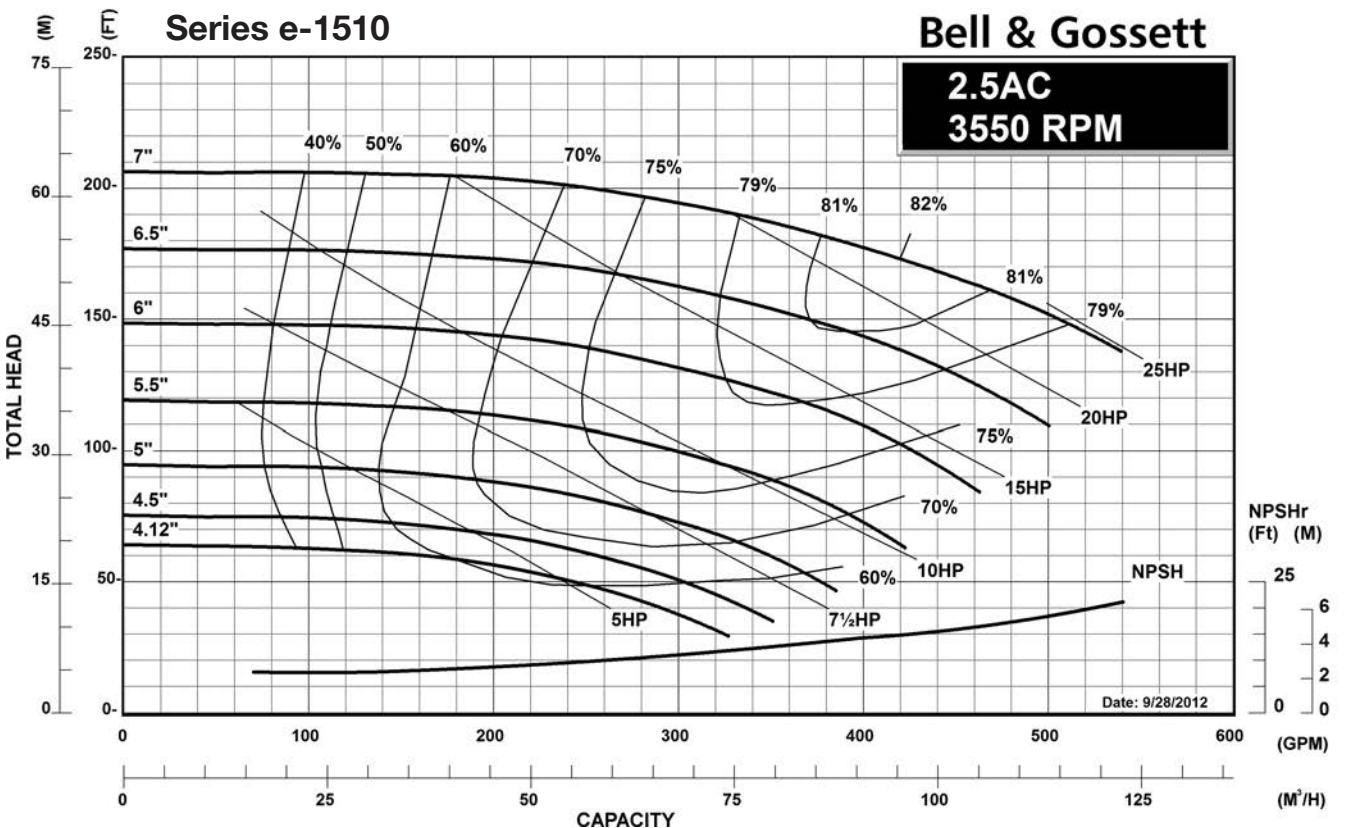
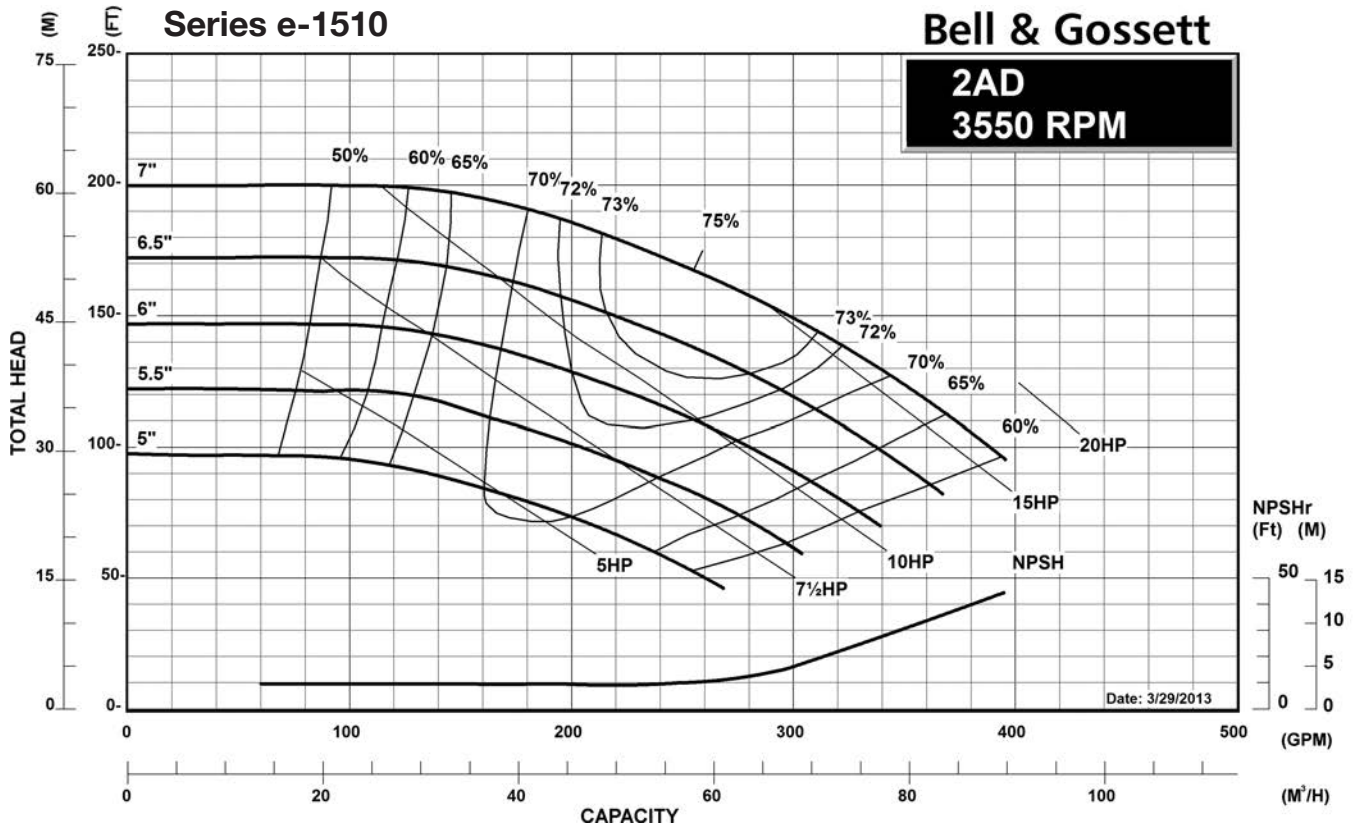

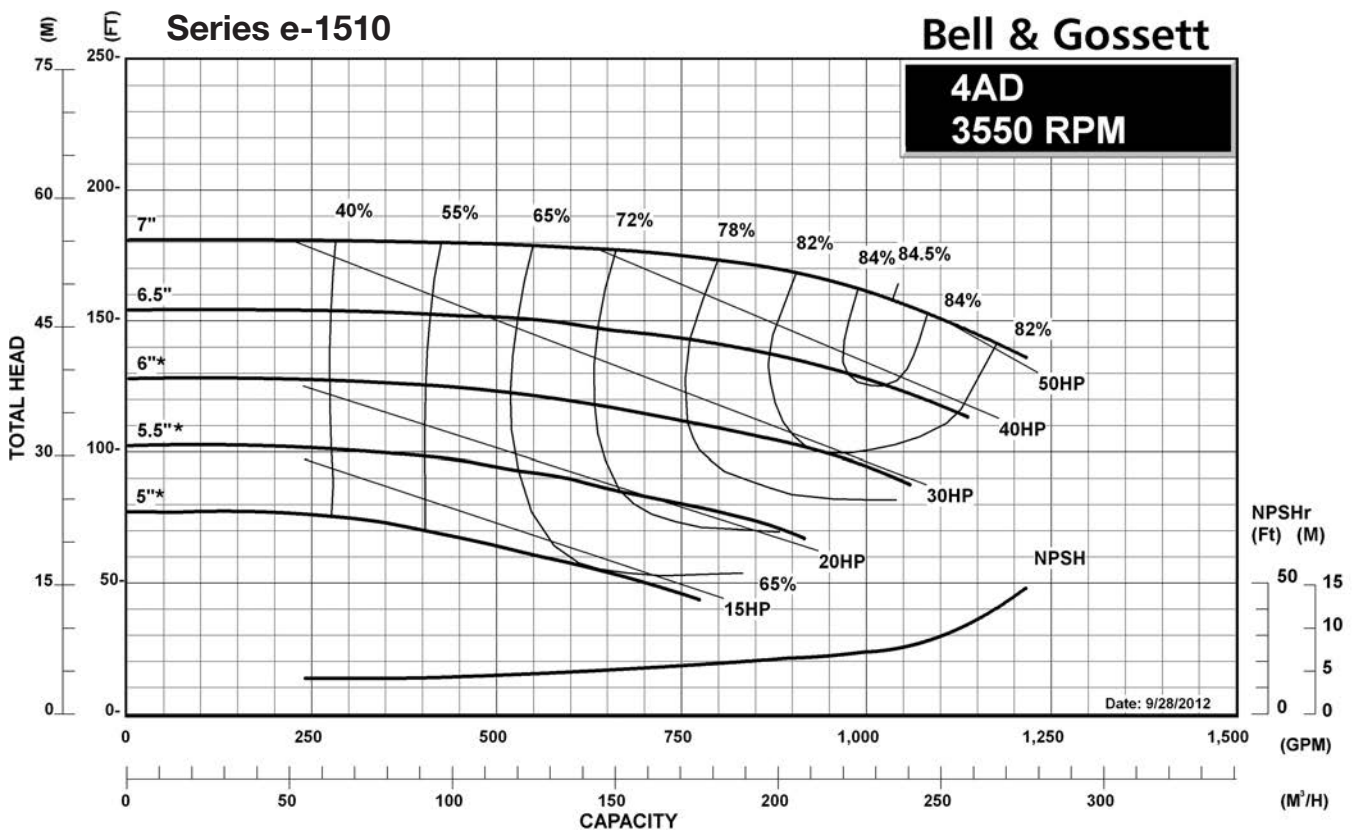
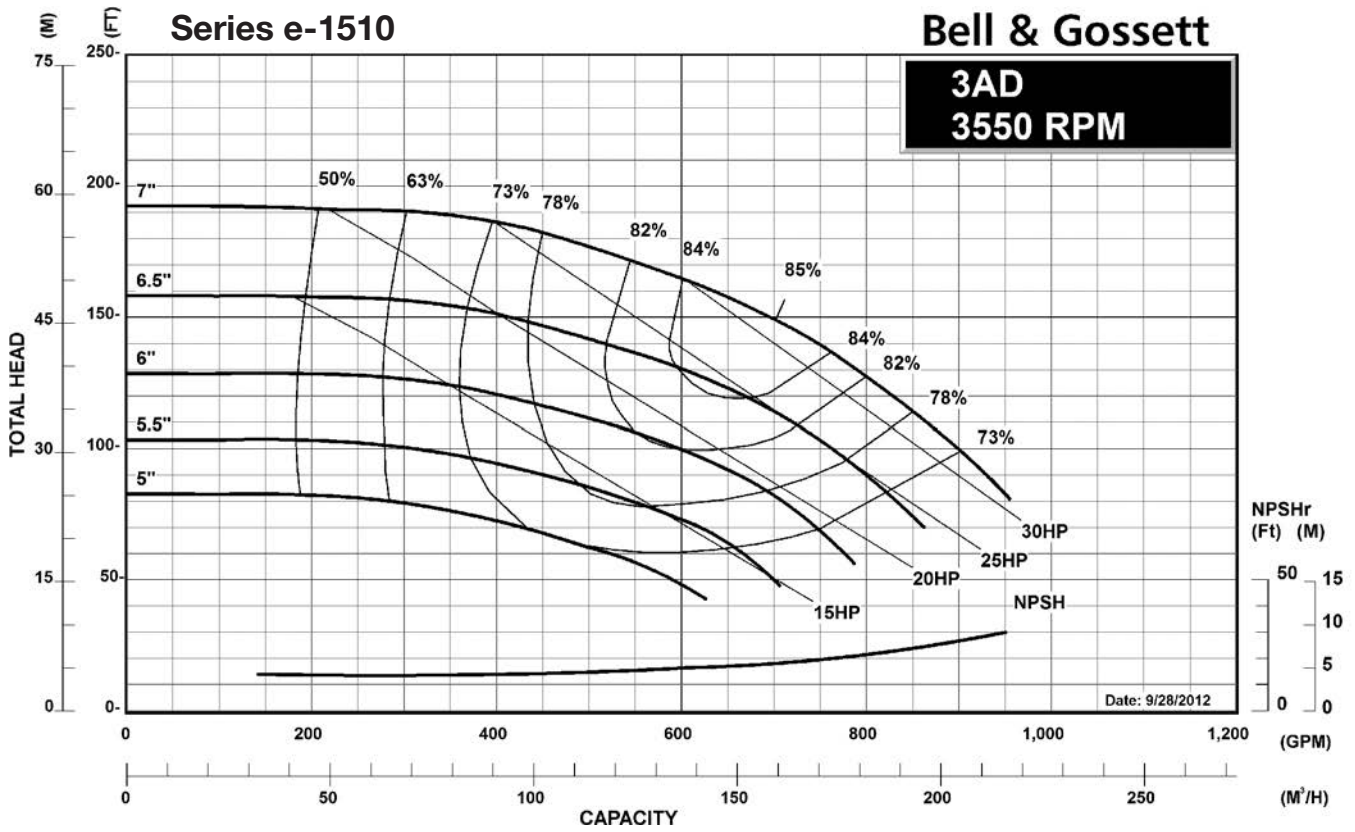

* 6" and below requires oversized diameter and angle trim. See manual.

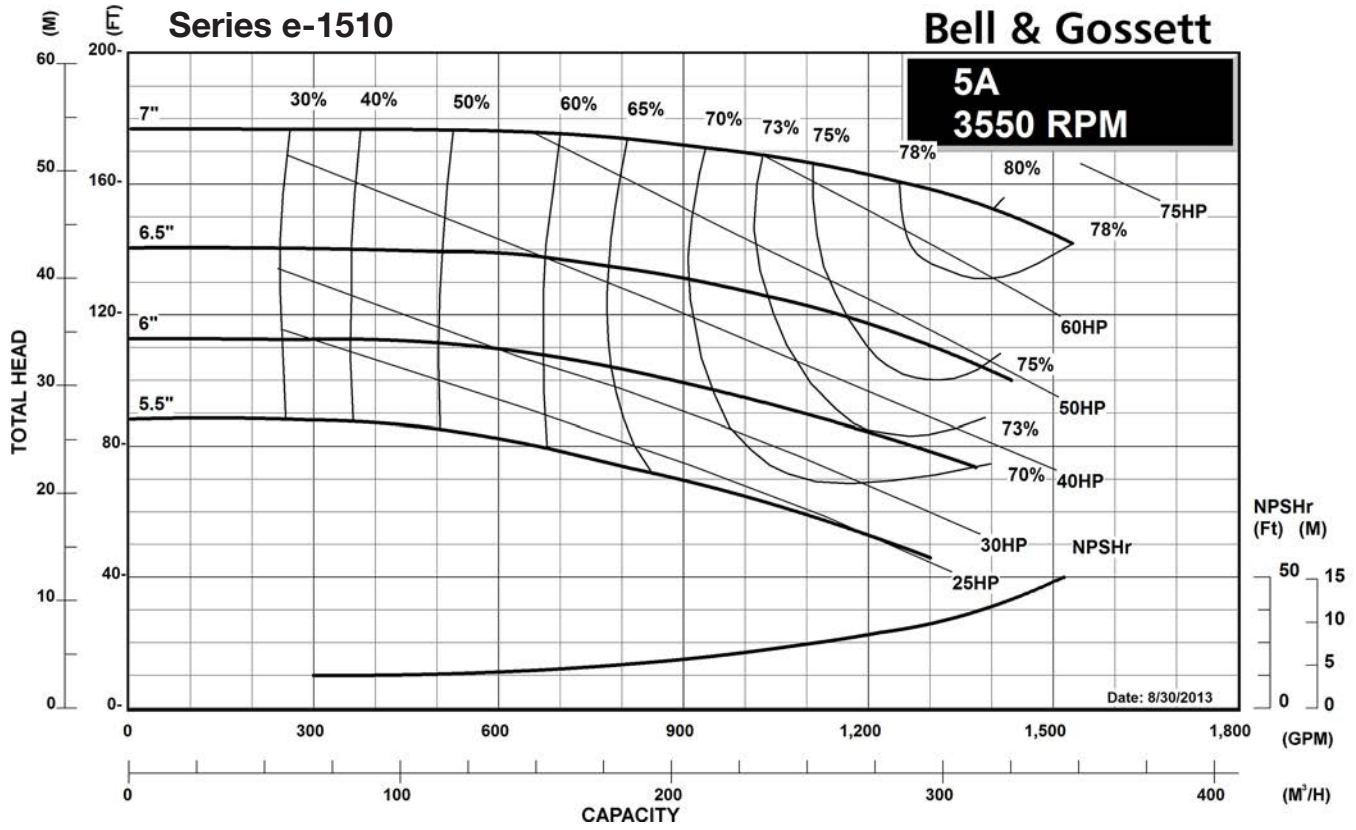

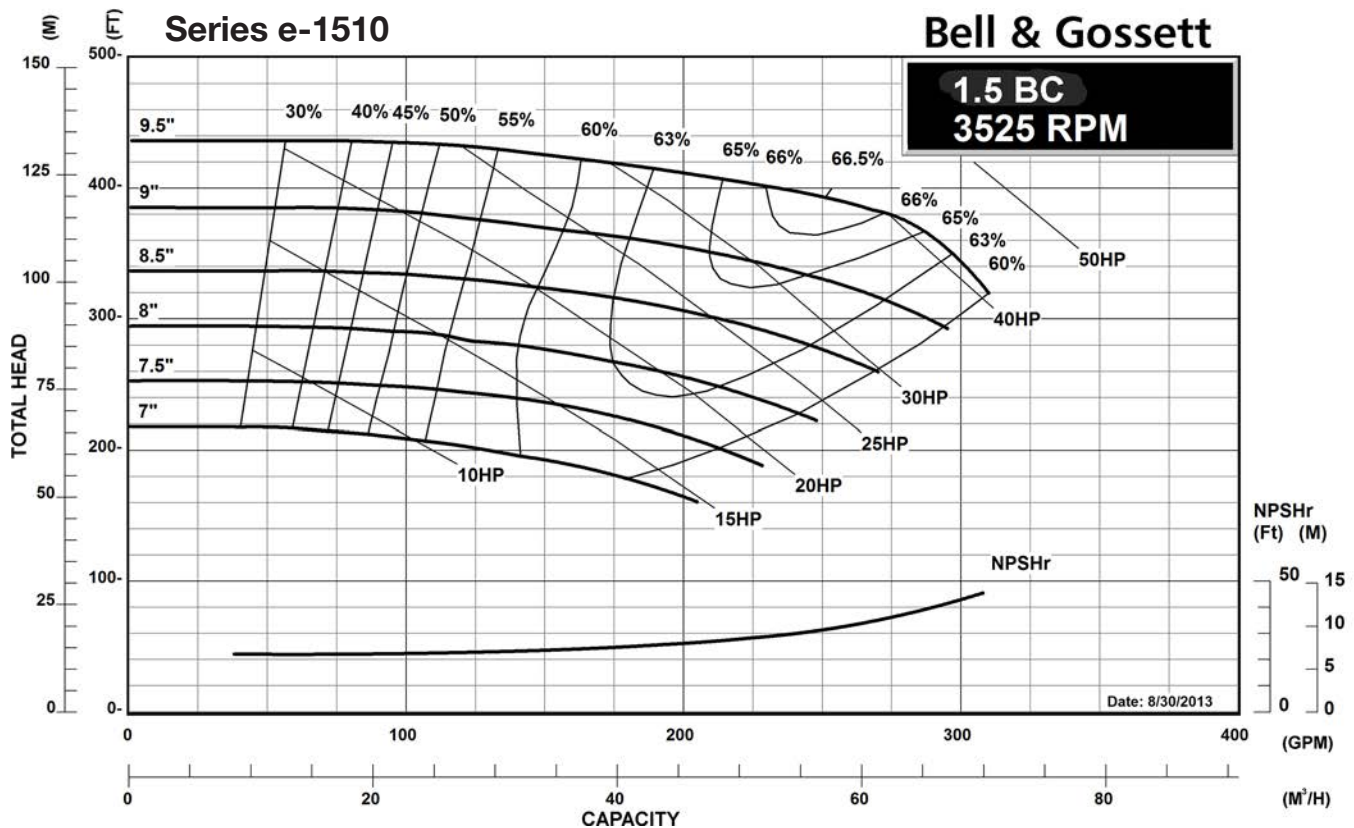
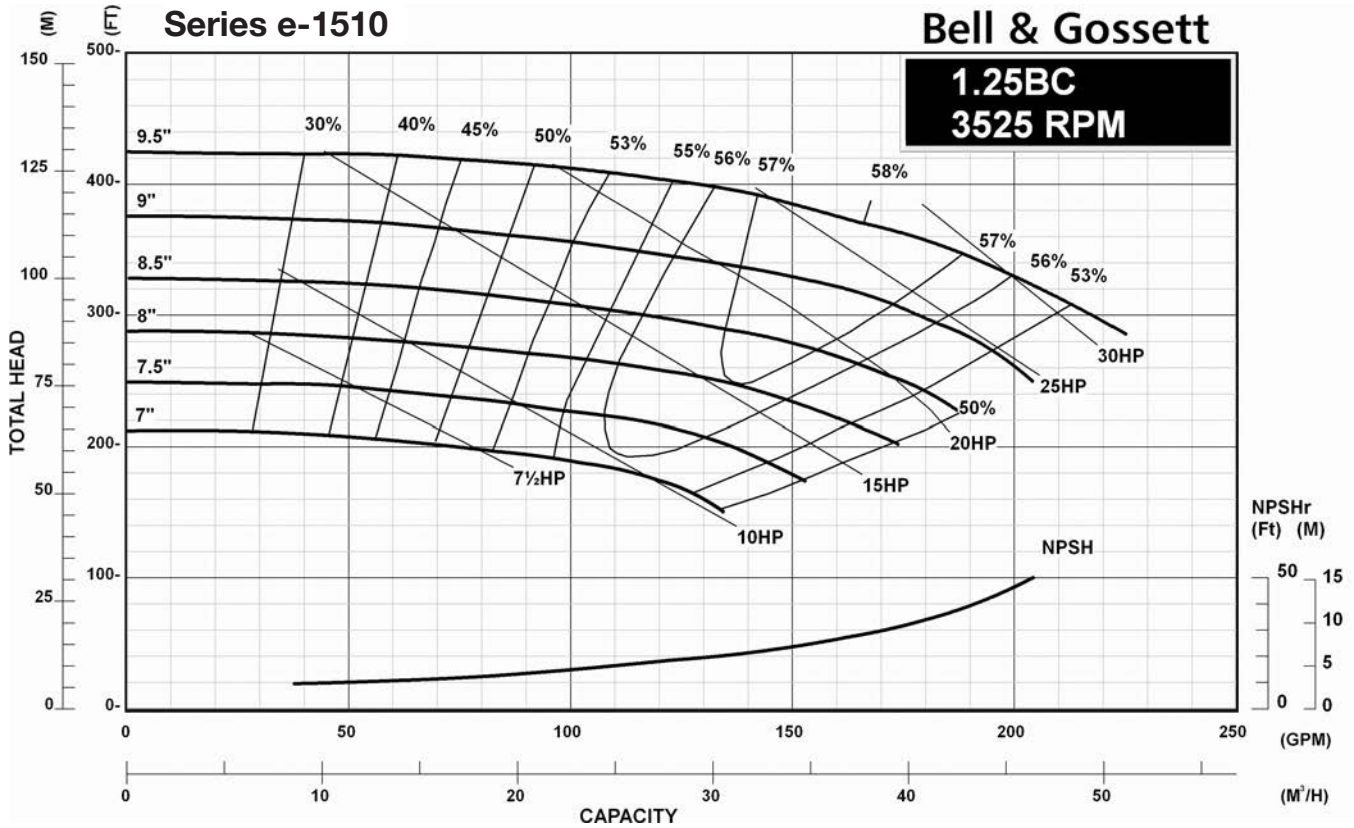

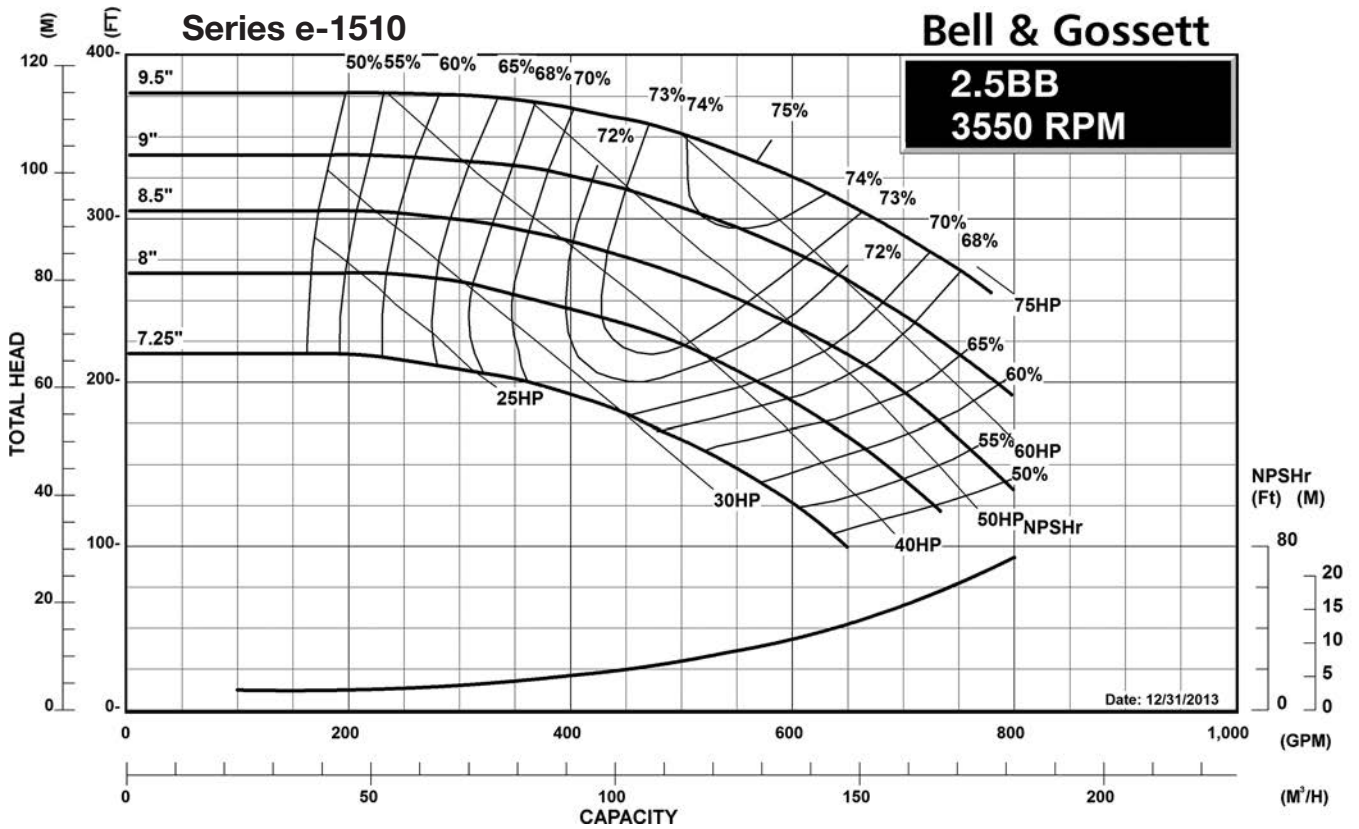
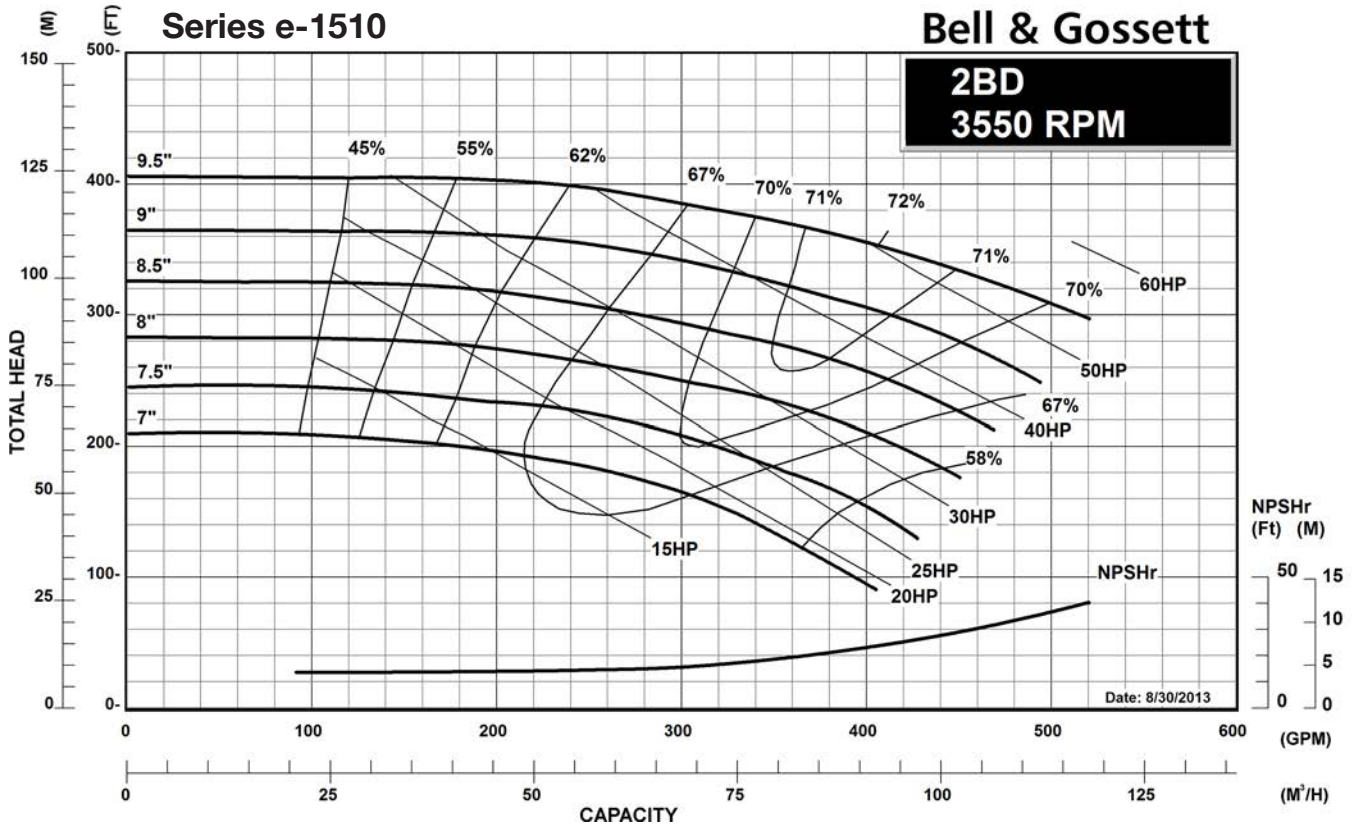

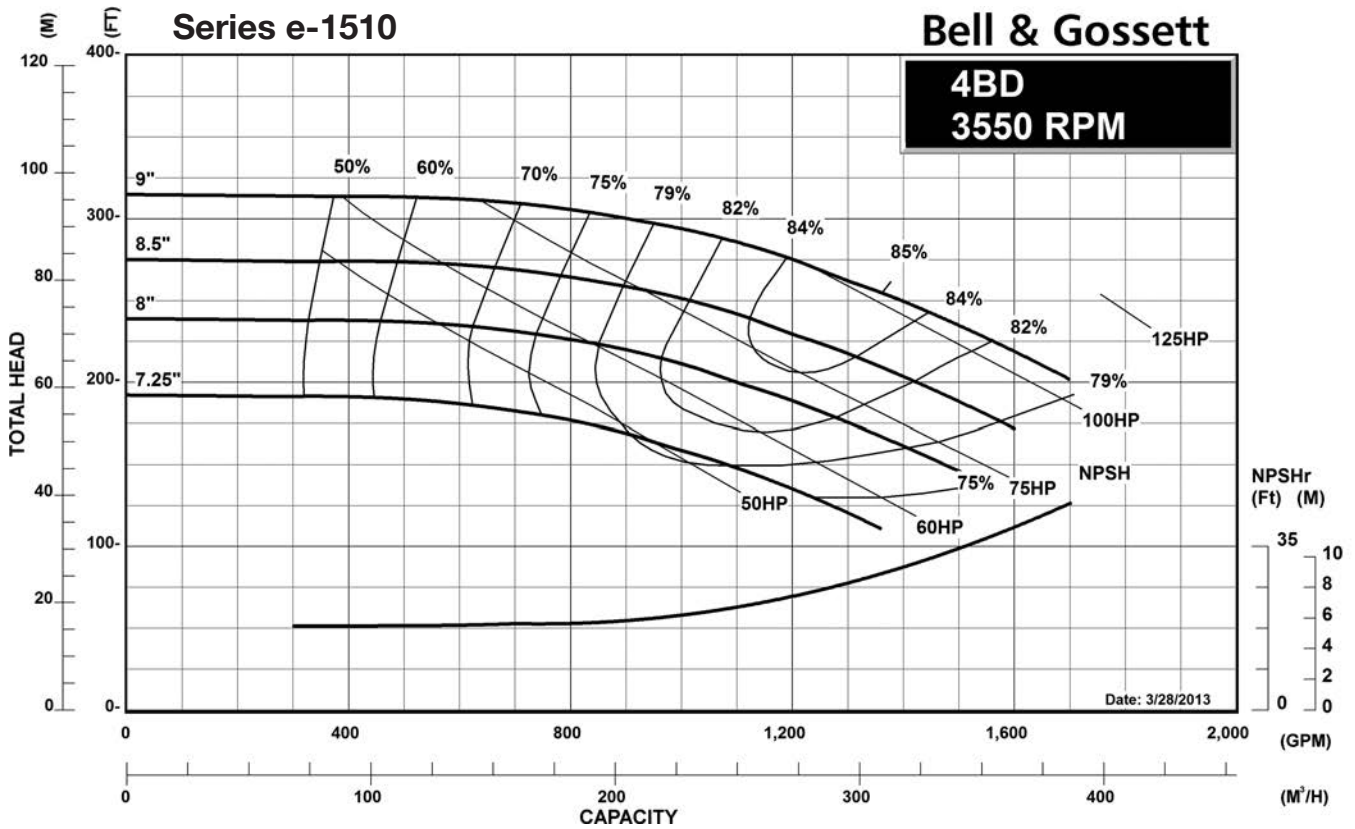
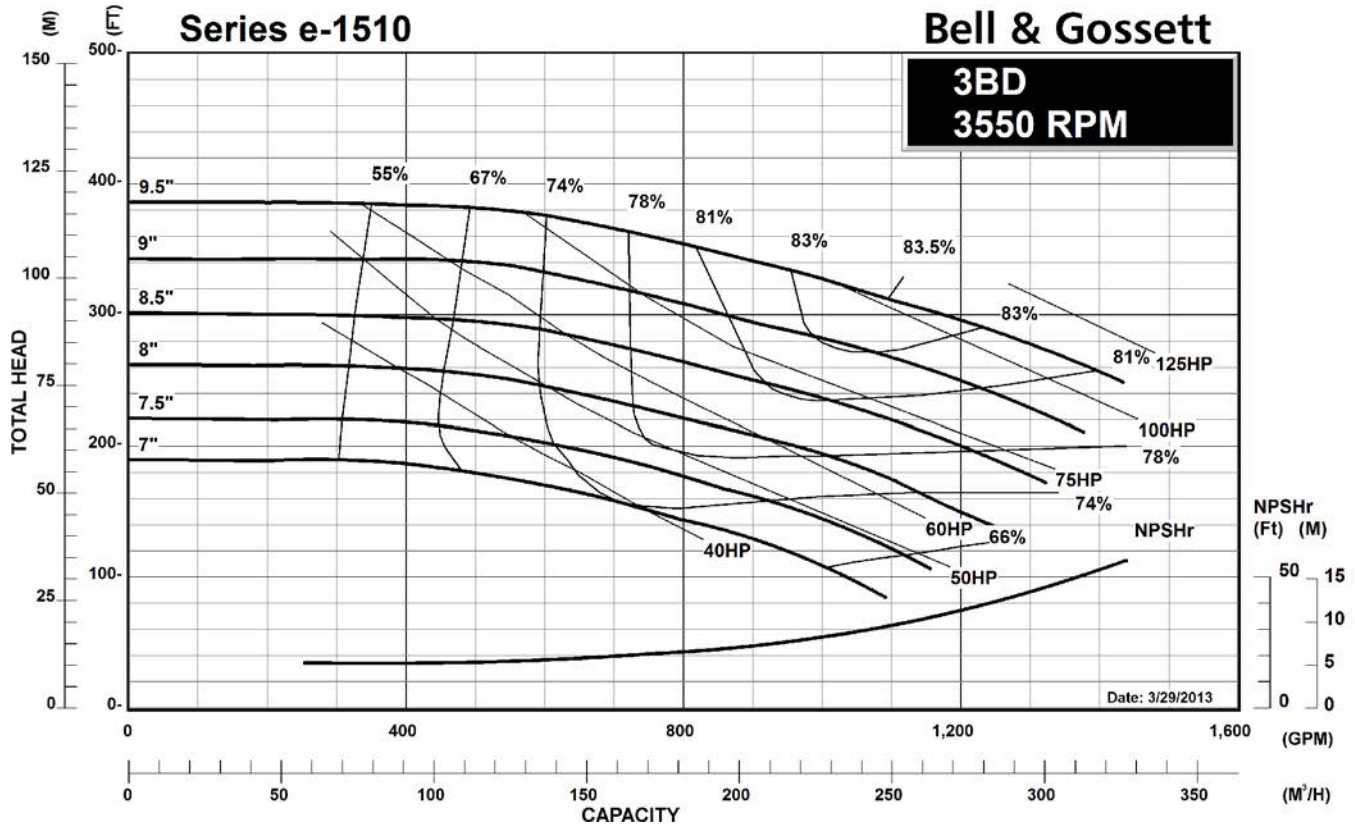

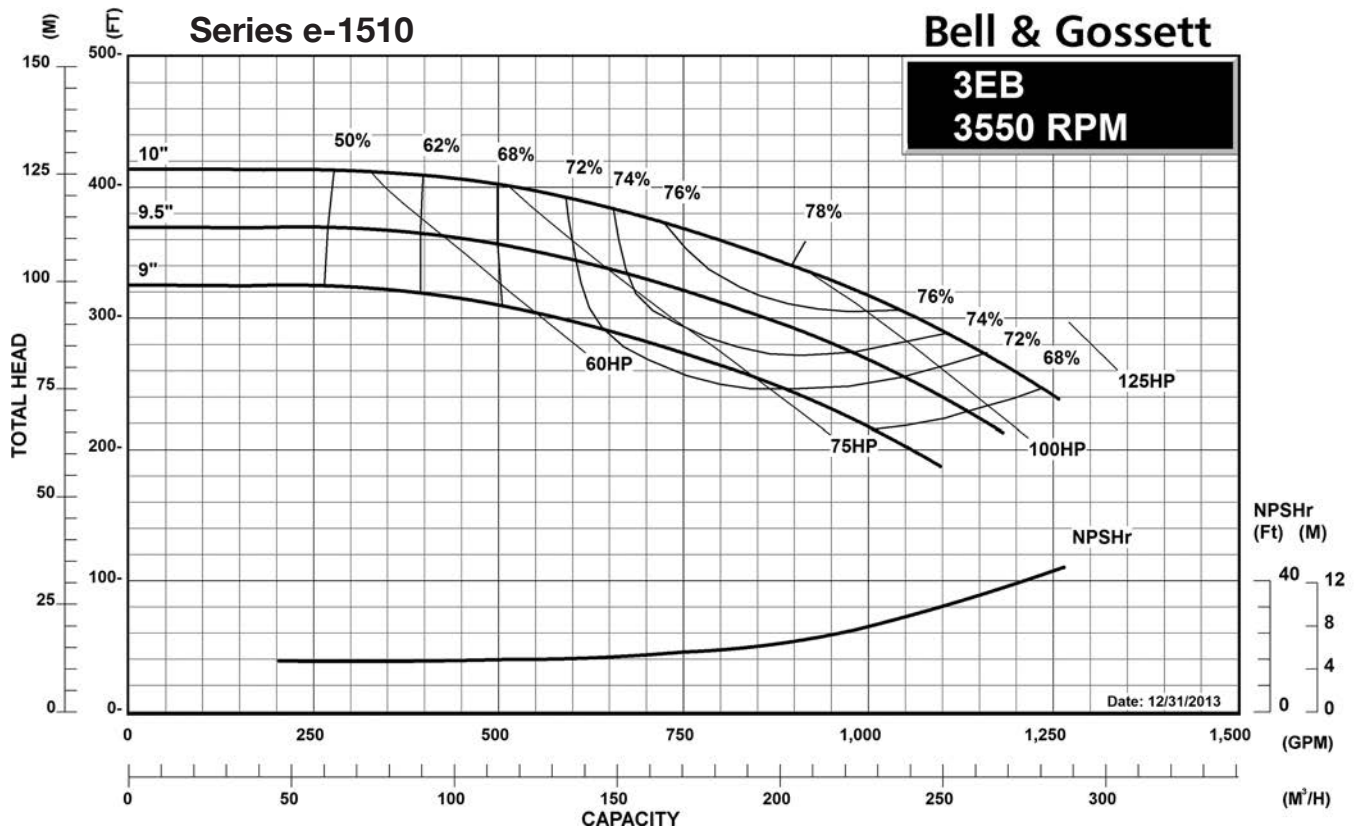
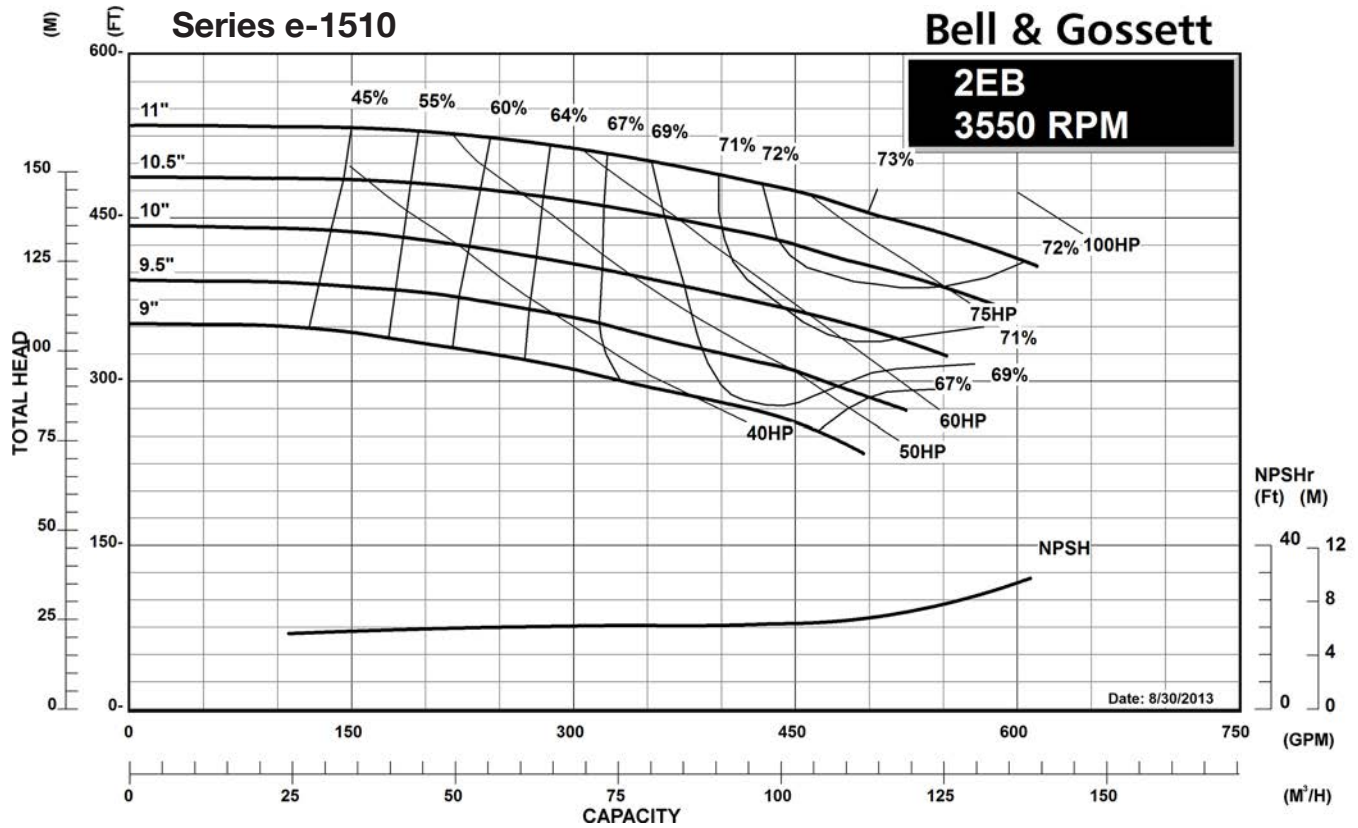

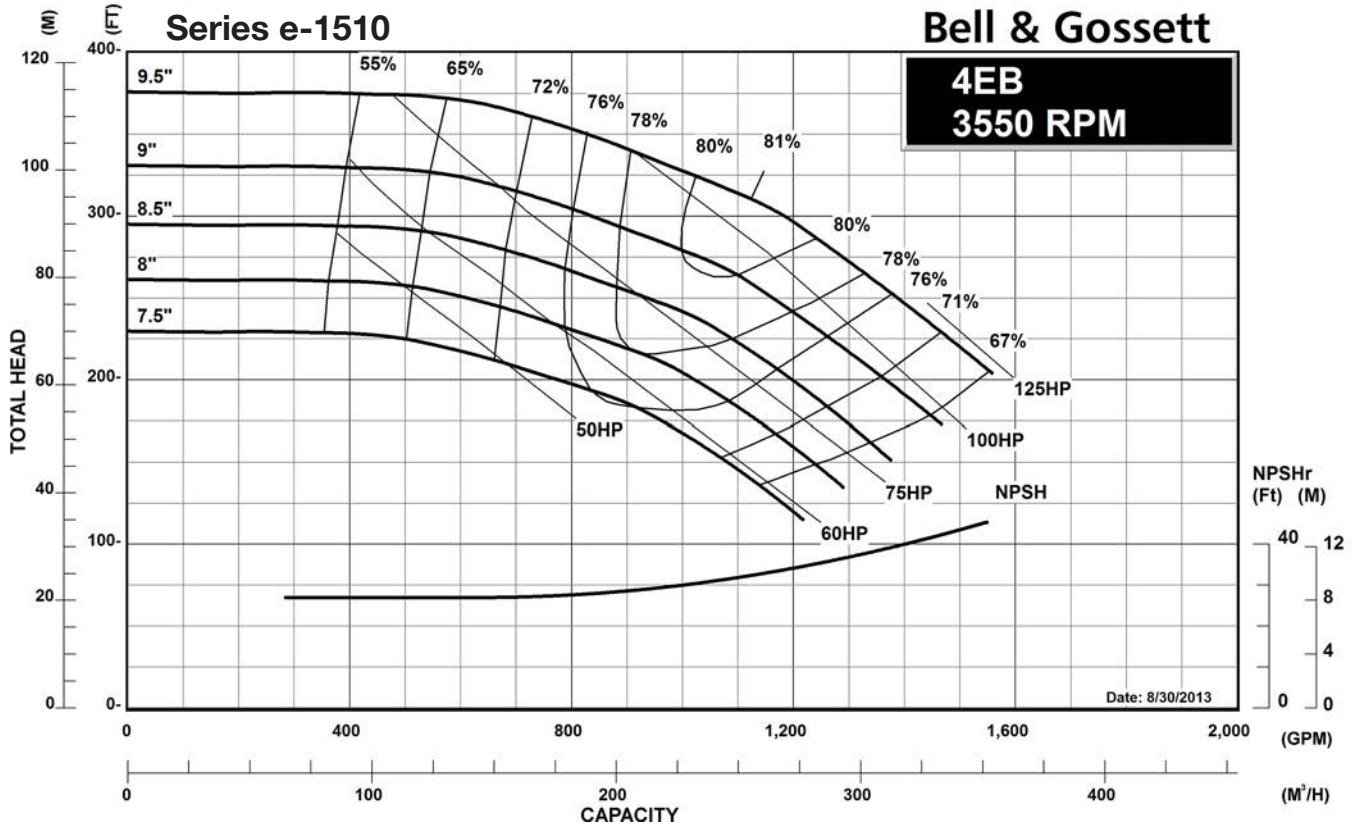

Xylem Inc.
 8200 N. Austin Avenue
 Morton Grove, Illinois 60053
 Phone: (847) 966-3700
 Fax: (847) 965-8379
www.bellgossett.com